



Clemas & Co Ltd

Industrial Cleaning Equipment
Sales - Hire - Service

TENNANT T5 SCRUBBER DRYER OPERATOR MANUAL



Clemas & Co. Unit 5 Ashchurch Business Centre, Alexandra Way, Tewkesbury,
Gloucestershire, GL20 8NB.

Tel: 01684 850777

Fax: 01684 850707

Email: info@clemas.co.uk

Web: www.clemas.co.uk

TABLE OF CONTENTS

SAFETY PRECAUTIONS	4	ADJUSTING SCRUB HEAD BRUSHES	19
SAFETY LABELS	5	DISK MODEL	19
MACHINE COMPONENTS	6	CYLINDRICAL BRUSH MODEL	19
CONTROL PANEL COMPONENTS	7	MACHINE MAINTENANCE	21
MACHINE INSTALLATION	8	DAILY MAINTENANCE	21
UNCRATING MACHINE	8	MONTHLY MAINTENANCE	23
INSTALLING BATTERIES	8	BATTERY MAINTENANCE	24
HOW THE MACHINE WORKS	9	SQUEEGEE BLADES	24
BRUSH AND PAD INFORMATION	9	MOTOR MAINTENANCE	25
MACHINE SETUP	9	FAST SYSTEM MAINTENANCE	25
ATTACHING SQUEEGEE ASSEMBLY	9	JACKING UP MACHINE	26
INSTALLING BRUSHES/PADS	10	TRANSPORTING MACHINE	26
INSTALLING FAST-PAK CARTON	11	STORING MACHINE	26
FILLING SOLUTION TANK	11	RECOMMENDED STOCK ITEMS	26
MACHINE OPERATION	12	TROUBLESHOOTING	27
PRE-OPERATION CHECKS	12	CONTROL PANEL FAULT INDICATOR CODES	29
STARTING THE MACHINE	12	MACHINE SPECIFICATIONS	30
EMERGENCY STOPPING	13		
WHILE OPERATING MACHINE	13		
BATTERY CHARGE LEVEL INDICATOR ...	14		
HOUR METER	14		
OFF-AISLE WAND OPERATION	14		
DRAINING AND CLEANING TANKS	15		
DRAINING RECOVERY TANK	15		
DRAINING SOLUTION TANK	16		
CHARGING BATTERIES	16		
BATTERY CHARGER SPECIFICATIONS ...	16		
ON-BOARD BATTERY CHARGER			
SETTINGS	16		
USING THE ON-BOARD BATTERY			
CHARGER	17		
ON-BOARD BATTERY CHARGER ERROR			
CODES	18		
USING AN OFF-BOARD BATTERY			
CHARGER	18		

SAFETY PRECAUTIONS

This machine is intended for industrial and commercial use. It is designed exclusively to scrub hard floors in an indoor environment and is not constructed for any other use. Only use recommended pads, brushes and commercially approved floor cleaners intended for machine application.

The following warning alert symbol and the "FOR SAFETY" heading are used throughout this manual as indicated in their description:

 **WARNING:** To warn of hazards or unsafe practices which could result in severe personal injury or death.

FOR SAFETY: To identify actions which must be followed for safe operation of equipment.

The following safety precautions signal potentially dangerous conditions to the operator or equipment. All operators must read, understand and practice them.

 **WARNING:** Fire Or Explosion Hazard

- Never Use Flammable Liquids Or Operate Machine In Or Near Flammable Liquids, Vapors Or Combustible Dusts.

This machine is not equipped with explosion proof motors. The electric motors will spark upon start up and during operation which could cause a flash fire or explosion if machine is used in an area where flammable vapors/liquids or combustible dusts are present.

- Do Not Pick Up Flammable Materials Or Reactive Metals.
- Batteries Emit Hydrogen Gas. Keep Sparks And Open Flame Away. Keep Battery Compartment Open When Charging.

 **WARNING:** Electrical Hazard

- Disconnect Battery Cables and Charger Plug Before Servicing Machine.
- Do Not Charge Batteries with Damaged Power Supply Cord. Do Not Modify Plug.

If the charger supply cord is damaged or broken, it must be replaced by the manufacturer or its service agent or a similarly qualified person in order to avoid a hazard.

 **WARNING:** Spinning Brush. Keep Hands Away. Turn Off Power Before Working On Machine.

FOR SAFETY:

1. Do not operate machine:
 - With flammable liquids or near flammable vapors as an explosion or flash fire may occur.
 - Unless trained and authorized.
 - Unless operator manual is read and understood.
 - If not in proper operating condition.
2. Before starting machine:
 - Make sure all safety devices are in place and operate properly.
3. When using machine:
 - Go slow on inclines and slippery surfaces.
 - Wear non-slip shoes.
 - Reduce speed when turning.
 - Report machine damage or faulty operation immediately.
 - Never allow children to play on or around.
 - Follow mixing and handling instructions on chemical containers.
 - Do not operate on inclines that exceed 5% (3°).
4. Before leaving or servicing machine:
 - Stop on level surface.
 - Turn off machine.
 - Set parking brake, if equipped.
 - Remove key.
5. When servicing machine:
 - Avoid moving parts. Do not wear loose jackets, shirts, or sleeves.
 - Disconnect battery cables and charger plug before working on machine.
 - Wear protective gloves and eye protection when handling batteries or battery cables.
 - Avoid contact with battery acid.
 - Do not power spray or hose off machine. Electrical malfunction may occur.
 - Jack machine up at designated locations only (See JACKING UP MACHINE).
 - Use hoist or jack that will support machine weight.
 - Use manufacturer supplied or approved replacement parts.
 - All repairs must be performed by a qualified service person.
 - Do not modify the machine from its original design.

6. When loading/unloading machine onto/off truck or trailer:
- Drain tanks before loading.
 - Use a ramp that can support the machine weight and person loading it. Do not exceed a 11° ramp incline at a ramp length of 3.7m.

- Turn machine off.
- Put scrub head in the lowered position.
- Block machine wheels.
- Use tie-down straps to secure machine.
- Set parking brake, if equipped.

SAFETY LABELS

The safety labels appear on the machine in the locations indicated. Replace labels if they are missing or become damaged or illegible.

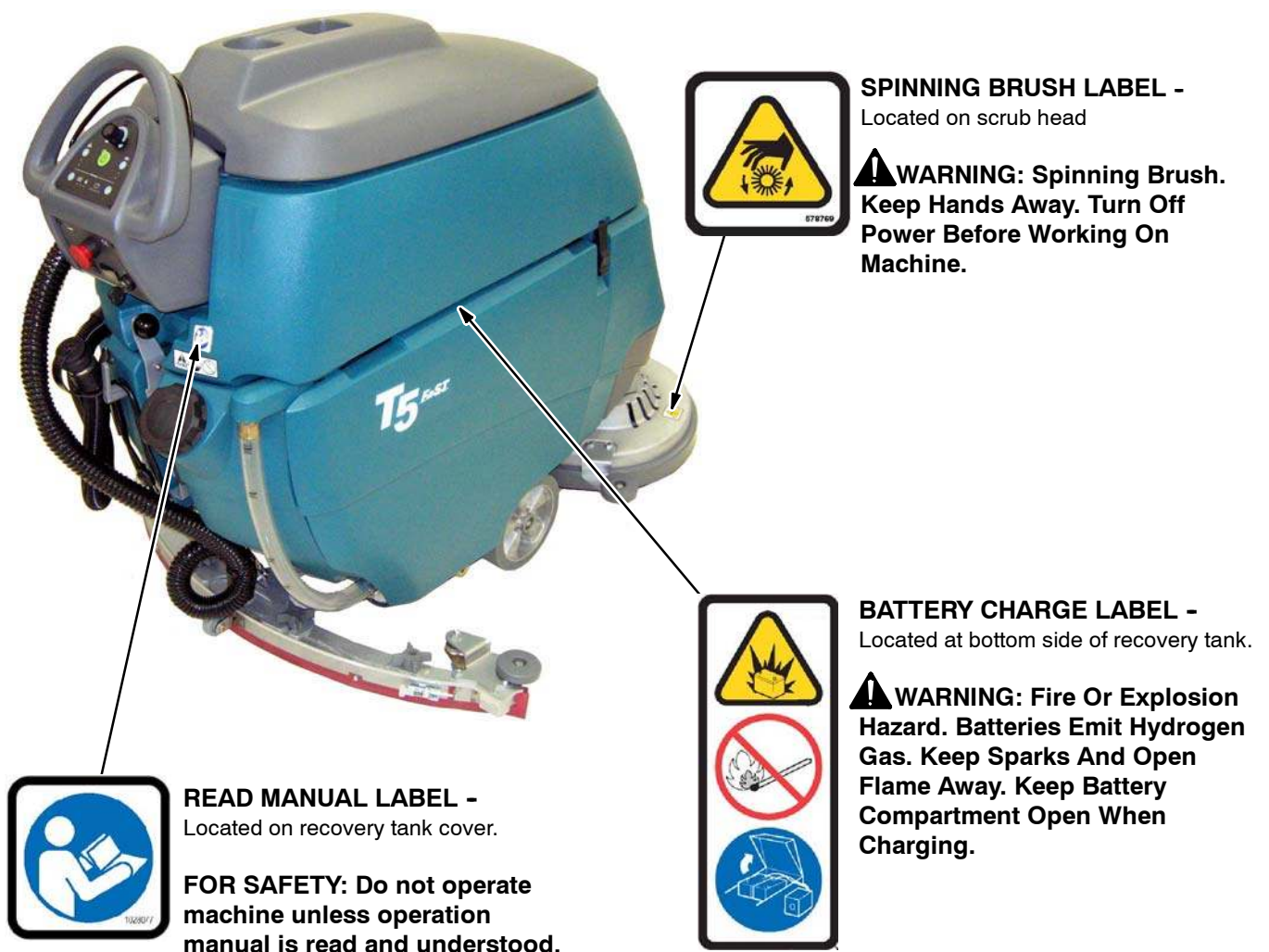

MACHINE COMPONENTS

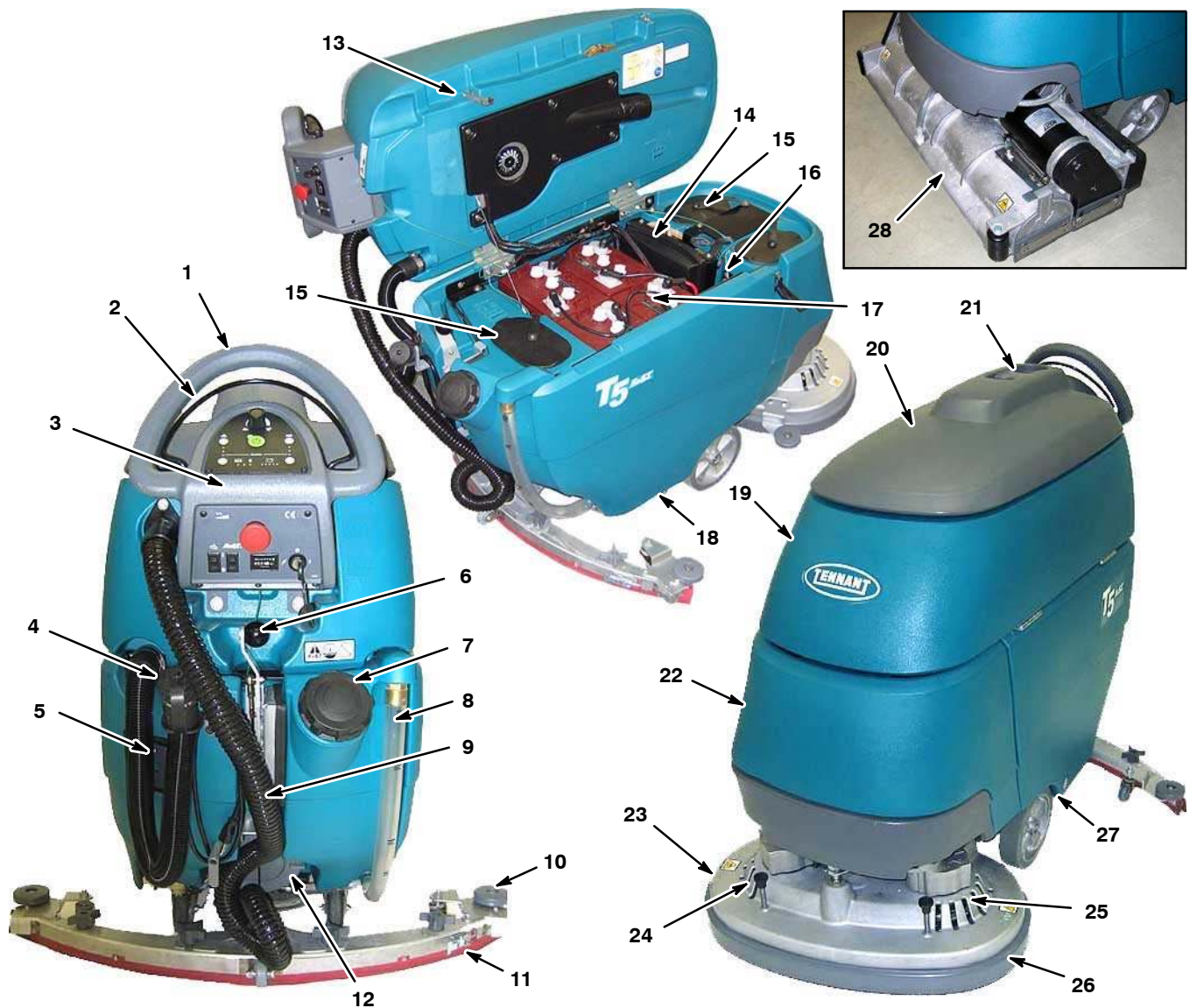

1. Control Handle
2. Control Handle Start Bail
3. Upper & Lower Control Panels
4. Recovery Tank Drain Hose
5. On-board Battery Charger
6. Squeegee Lift Lever
7. Rear Fill-Port
8. Solution Tank Level/Drain Hose
9. Squeegee Vacuum hose
10. Wall Rollers
11. Squeegee Assembly
12. Solution Tank Clean-Out Port
13. Recovery Tank Support Stand
14. Control Board
15. Bucket Fill Port/Clean-out Port
16. FaST-PAK Carton Compartment
17. Batteries
18. Off-Aisle Wand Solution Hose Coupler
19. Recovery Tank
20. Recovery Tank Cover

21. Cup Holder
22. Solution Tank
23. Disk Scrub Head
24. Pad Release Plunger
25. Pad Driver Window
26. Scrub Head Skirt
27. Parking Brake
28. Cylindrical Brush Scrub Head

CONTROL PANEL COMPONENTS

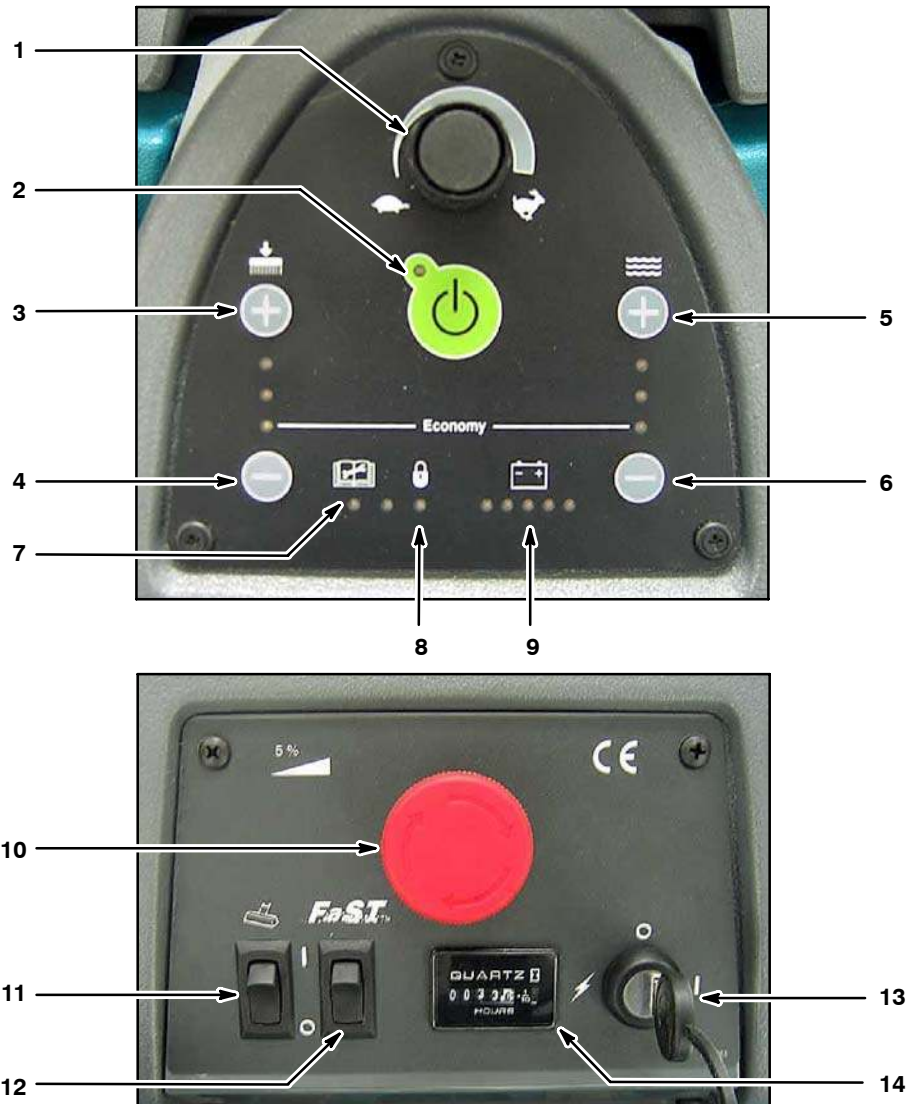

- | | |
|---|--|
| <ul style="list-style-type: none"> 1. Speed control knob 2. 1-STEP scrub button 3. Brush pressure increase button (+) 4. Brush pressure decrease button (-) 5. Solution flow increase button (+) 6. Solution flow decrease button (-) 7. Fault indicator - Contact Service | <ul style="list-style-type: none"> 8. Supervisor Control indicator - Lockout feature 9. Battery charge level indicator 10. Emergency stop button 11. Off-Aisle wand on/off switch (option) 12. FaST system on/off switch (option) 13. Main power on/off key switch 14. Hour meter |
|---|--|

MACHINE INSTALLATION

UNCRATING MACHINE

1. Carefully check the shipping crate for signs of damage. Report damage at once to carrier.
2. Check the contents list. Contact distributor for missing items.

Contents:

- 4-6 V Batteries-Optional
- 3-Battery Cable Jumpers
- Battery Tray
- 1-FaST-PAK 365 Concentrate-Optional
- Squeegee Assembly
- 2-Pad drivers (Disk Model)
- 2-Brushes (Cylindrical Brush Model)

3. To uncrate your machine, remove the shipping hardware and straps that secure the machine to the pallet. Carefully back machine down ramp.

ATTENTION: Do not roll machine off pallet unless a ramp is used, machine damage may occur.

ATTENTION: To prevent possible machine damage, install batteries after removing machine from shipping pallet.

INSTALLING BATTERIES

⚠ WARNING: Fire Or Explosion Hazard. Batteries Emit Hydrogen Gas. Keep Sparks And Open Flame Away. Keep Battery Hood Open When Charging.

FOR SAFETY: When installing batteries, wear protective gloves and eye protection. Avoid contact with battery acid.

Battery Specifications:

Four 6 volt, 180A/5h or 200A/5h deep cycle batteries.
 Maximum battery dimensions:
 190 mm W x 275 mm L x 284 mm H.

1. Park the machine on a level surface, remove the key and set the parking brake.
2. Lift the recovery tank and remove the right side battery compartment panel (Figure 1). 13mm wrench required.



FIG. 1

3. Carefully install the batteries into the battery compartment tray (Figure 2). Arrange the battery posts as shown (Figure 3).



FIG. 2

4. Connect the battery cables to the battery posts as shown (Figure 3), RED TO POSITIVE (+) and BLACK TO NEGATIVE (-).

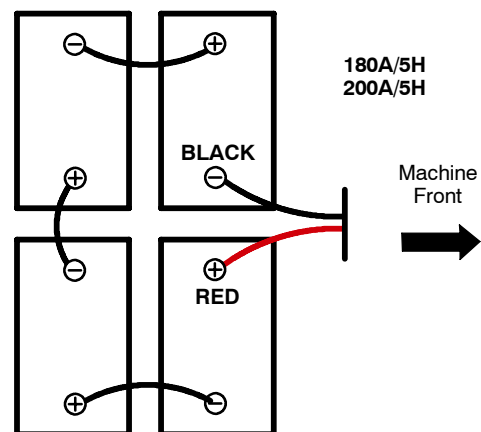

FIG. 3

IMPORTANT: If your machine is equipped with the on-board battery charger, make sure that the charger is properly set for your battery type before charging (See ON-BOARD CHARGER SETTINGS).

HOW THE MACHINE WORKS

Conventional Scrubbing:

Water and detergent from the solution tank flow to the floor through a solution valve. The brushes use the detergent and water to scrub the floor clean. As the machine moves forward, the squeegee wipes the dirty solution from the floor into the recovery tank.

Foam Scrubbing (FaST Model):

(FaST-Foam activated Scrubbing Technology)
Unlike conventional scrubbing, the FaST system injects the FaST-PAK concentrate formula with a small amount of water and air onto the floor. The mixture creates a large volume of expanded wet foam for the brush to scrub the floor clean. As the machine moves forward, the foam collapses and the squeegee recovers the dirty solution into the the recovery tank leaving the floor clean dry and slip free.

BRUSH AND PAD INFORMATION

For best cleaning results use the appropriate brush type for your cleaning application. Refer to the Parts manual for part number information.

Polypropylene Bristle Scrub Brush (Black) -

This general purpose polypropylene bristle scrub brush is used for scrubbing lightly compacted soilage. This brush works well for maintaining concrete, wood and grouted tile floors.

Soft Nylon Bristle Scrub Brush (White) -

Recommended for cleaning coated floors without removing finish. Cleans without scuffing.

Super Abrasive Bristle Scrub Brush (Gray) -

Nylon fiber impregnated with abrasive grit to remove stains and soilage. Strong action on any surface. Performs well on buildup, grease, or tire marks.

Polishing Pad (White) -

Used to maintain highly polished or burnished floors.

Buffing Pad (Red) - Used for light duty scrubbing without removing floor finish.

Scrubbing Pad (Blue) - Used for medium to heavy-duty scrubbing. Removes dirt, spills, and scuffs and leaves surface clean ready for recoating.

Stripping Pad (Brown) - Used for stripping of floor finish to prepare the floor for recoating.

Heavy Duty Stripping Pad (Black) - Used for aggressive stripping of heavy finishes/sealers, or very heavy duty scrubbing.

MACHINE SETUP

ATTACHING SQUEEGEE ASSEMBLY

1. Park the machine on a level surface, remove the key and set the parking brake if equipped.
2. Lift the squeegee lift lever to the upward position (Figure 4).



FIG. 4

3. Mount the squeegee assembly to the squeegee pivot bracket and secure with knobs (Figure 5).

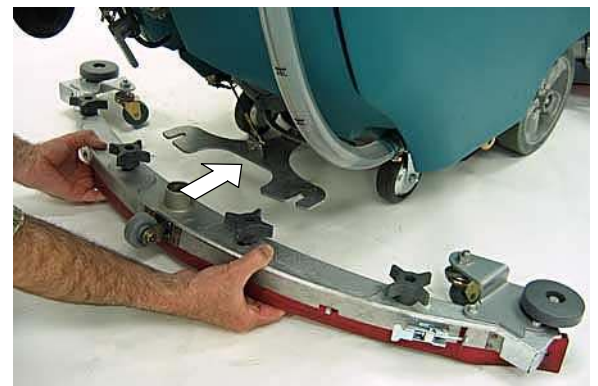

FIG. 5

4. Connect the vacuum hose to the squeegee assembly. Loop the hose as shown using the hose clip provided (Figure 6).



FIG. 6

5. Check the squeegee blades for proper deflection. The blades should deflect as shown (Figure 7).



FIG. 7

6. To adjust the blade deflection, place the squeegee assembly on a level surface and adjust the casters as shown (Figure 8).



FIG. 8

INSTALLING BRUSHES/PADS

FOR SAFETY: Before installing brushes, stop machine on level surface, remove key and set parking brake if equipped.

Disk Model:

1. Raise scrub head off the floor and remove key.
2. Attach the pad to the pad driver before installing the driver. Secure pad with centerlock (Figure 9).

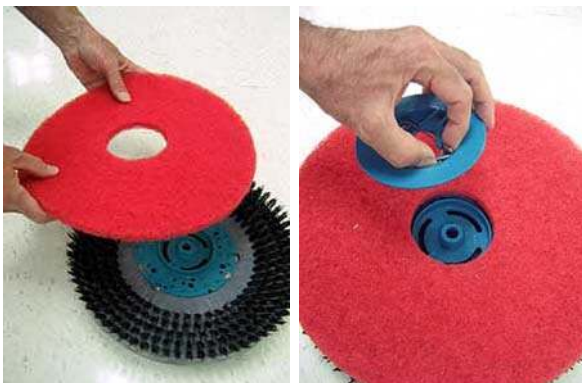

FIG. 9

3. Align the pad driver under the motor hub and push it upward to engage (Figure 10).



FIG. 10

4. To remove the pad driver, raise the scrub head and push the pad release plunger downward (Figure 11).



FIG. 11

5. Check the scrub head to ensure that it is properly adjusted (See ADJUSTING SCRUB HEAD BRUSHES).

Cylindrical Brush Model:

1. Raise scrub head off the floor and remove key.
2. Remove idler plate from scrub head by pressing the spring tab downward (Figure 12).



FIG. 12

3. Attach idler plate to the brush end that has the double row of bristles (Figure 13). Install brush.



FIG. 13

4. Check the brushes to ensure they are properly adjusted (See ADJUSTING SCRUB HEAD BRUSHES).

INSTALLING FaST-PAK CARTON (FaST Model)

ATTENTION: The FaST-PAK Concentrate Formula is specifically designed for the FaST system. NEVER use a substitute. Machine damage may result.

1. Pull out the hose connector from the FaST-PAK carton and remove cap (Figure 14).

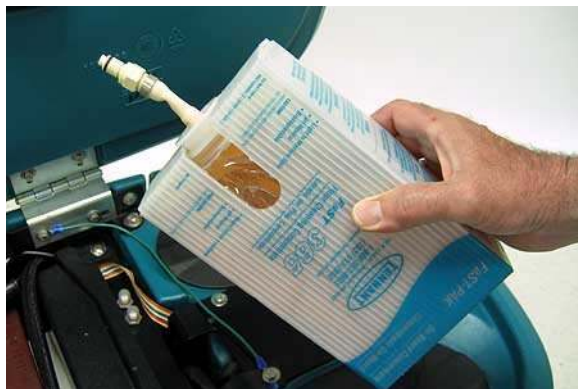

FIG. 14

2. Open the battery compartment. Connect the FaST-PAK carton to the supply hose and place carton in compartment (Figure 15). **Make sure the hose does not get pinched.**



FIG. 15

3. When the supply hose is not in use, connect the storage plug to prevent the FaST system from drying out and clogging up the hose. (Figure 16).



FIG. 16

FILLING SOLUTION TANK

Using a hose or bucket, fill the solution tank to the "MAX 85L" mark (Figure 17).

For FaST Scrubbing: Use cool clean water only (less than 21°C). Do not add any conventional floor cleaning detergents, FaST system failure may result.

For Conventional Scrubbing: Use hot water (60°C maximum). Pour a recommended cleaning detergent into the solution tank according to mixing instructions on the container.



FIG. 17

ATTENTION: For conventional scrubbing, only use commercially approved cleaning detergents. Machine damage due to improper detergent usage will void the manufacturer's warranty.

⚠ WARNING: Fire or Explosion Hazard. Never Use Flammable Liquids.

MACHINE OPERATION

FOR SAFETY: Do not operate machine, unless operator manual is read and understood.

⚠ WARNING: Fire Or Explosion Hazard. Never Operate Machine In Or Near Flammable Liquids, Vapors Or Combustible Dusts.

PRE-OPERATION CHECKS

- Sweep area.
- Check the battery charge level indicator.
- Check the brushes/pads for wear.
- Check the squeegee blades for wear and proper adjustment.
- Make sure the recovery tank is empty and the float shut-off screen is installed and clean.
- Check the scrub head skirt for wear.
- Foam Scrubbing (FaST model): Check the FaST-PAK concentrate level.
- Foam Scrubbing (FaST model): Make sure the solution tank is filled with cool clean water only.
- Foam Scrubbing (FaST model): Ensure that all conventional cleaning agents are drained and rinsed from solution tank.

STARTING THE MACHINE

1. Release the parking brake if equipped (Figure 18).
2. Turn the key to the on (I) position (Figure 18).



FIG. 18

3. To foam scrub (FaST model), press the FaST system switch to the on (I) position (Figure 19).

IMPORTANT: NEVER turn the FaST system switch on when conventional scrubbing. Conventional cleaning detergents/restorers may cause failure to the FaST injection system. Drain, rinse and refill solution tank with cool clean water before operating the FaST system.



FIG. 19

4. Lower the squeegee assembly to floor by lowering the squeegee lift lever (Figure 20).



FIG. 20

5. Press the 1-STEP scrub button (Figure 21).



FIG. 21

6. Pull the control handle bail to start scrubbing (Figure 22). To reverse the machine, simply push the control handle bail forward. Raise squeegee when reversing machine.

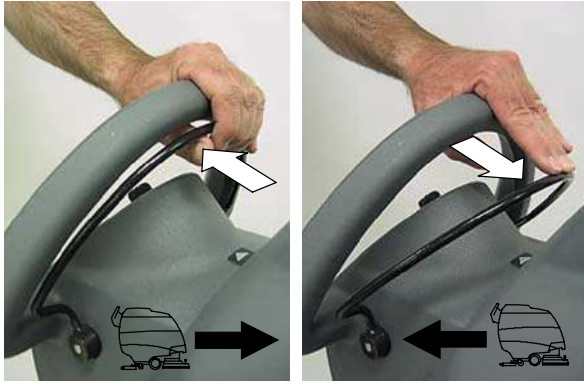

FIG. 22

- Adjust the speed control knob to a desired scrubbing speed (Figure 23).

NOTE: 45–60 meters per minute is the recommended scrubbing speed.



FIG. 23

- Press the brush pressure and solution flow buttons to increase (+) or decrease (-) as needed (Figure 24). To shut off the solution flow, continue to press the decrease button (-) until the lights turn off.

NOTE: When foam scrubbing (FaST), the solution flow lights will not light up. The FaST system solution flow rate is fixed and requires no adjustment.



FIG. 24

- To stop scrubbing, release the control handle bail, press the 1-STEP scrub button and raise the squeegee.

EMERGENCY STOPPING

Strike the emergency stop button, if equipped, in the event of an emergency (Figure 25). This button shuts off all power to machine. Turn the button clockwise and restart the key to regain power.



FIG. 25

WHILE OPERATING MACHINE

⚠ WARNING: Fire Or Explosion Hazard. Do Not Pick Up Flammable Materials Or Reactive Metals.

- Overlap each scrub path by 5 cm.
- Keep the machine moving to prevent damage to floor finish.
- Do not operate the machine on inclines that exceed 5% (3°). 
- Conventional scrubbing: Pour a commercially approved foam control solution into the recovery tank if excessive foam appears.

ATTENTION: Do not allow foam to enter the float shut-off screen, vacuum motor damage will result. Foam will not activate the float shut-off screen.

- For heavily soiled areas, use the double scrubbing method. First scrub the area with the squeegee up, let solution set for 3–5 minutes, then scrub the area a second time with squeegee down.
- When leaving the machine unattended, remove the key and set the parking brake, if equipped.
- If the machine detects a fault, the control panel lights will blink a fault code (See CONTROL PANEL FAULT INDICATOR CODES).

BATTERY CHARGE LEVEL INDICATOR

The battery charge level indicator displays the charge level of the batteries (Figure 26). When the batteries are fully charged, all five indicator lights will glow. As the batteries discharge, the indicator lights will begin to go out from right to left.

When the discharge level reaches the red light, the operator will have approximately one minute to continue scrubbing. When the red light begins to flash the scrubbing functions will automatically shut off to alert the operator to recharge the batteries. By pressing the 1-STEP Scrub button, when the red light is flashing, the operator will get an additional minute of scrubbing.

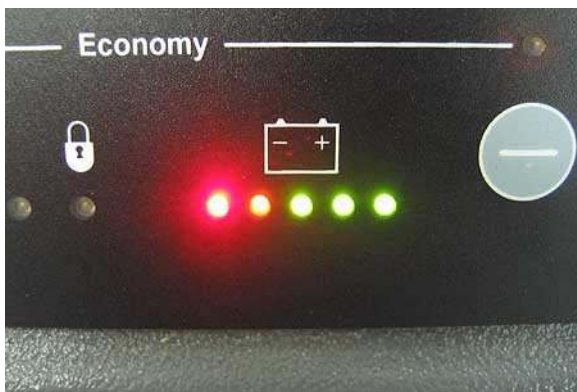

FIG. 26

HOUR METER

The hour meter records the number of total hours the vacuum and brush motors have been powered on. Use the hour meter to determine when to perform recommended maintenance procedures and to record service history (Figure 27). See MOTOR MAINTENANCE.



FIG. 27

OFF-AISLE WAND SETUP AND OPERATION

If your machine is equipped with the off-aisle wand option, this allows you to scrub areas where the machine is unable to reach.

Preparing Machine for Off-Aisle Wand Scrubbing:

1. Park the machine on a level surface, turn key off and set parking brake if equipped.
2. Connect the solution hose to the coupler at the lower right side of machine (Figure 28).



FIG. 28

3. Using the hose adapter, connect the squeegee hose to the wand hose (Figure 29).



FIG. 29

4. Attach the off-aisle wand to the hoses (Figure 30).



FIG. 30

Operating the Off-Aisle Wand:

1. Turn the key and wand switch to the on (I) position (Figure 31). The FaST system switch is disabled when operating the wand.



FIG. 31

2. Lower the squeegee to activate the vacuum motor (Figure 32).



FIG. 32

3. Squeeze trigger to activate solution. Use brush for scrubbing and squeegee for pickup (Figure 33).



FIG. 33

4. After scrubbing, turn off the wand switch and squeeze the trigger for five seconds to relieve the water pressure before disconnecting the solution hose.

⚠ WARNING: Fire or Explosion Hazard. Do Not Pick Up Flammable Materials Or Reactive Metals.

DRAINING AND CLEANING TANKS

After each use, the tanks should be drained and cleaned.

DRAINING RECOVERY TANK

1. Transport machine to disposal area and turn key switch off.
2. While holding the drain hose upward, remove the cap and lower hose to drain (Figure 34).



FIG. 34

3. After draining, open the recovery tank and clean out the tank (Figure 35).



FIG. 35

4. Clean the float shut-off screen and debris tray located in the recovery tank (Figure 36).



FIG. 36

DRAINING SOLUTION TANK

1. To drain remaining water from the solution tank, pull the solution tank level hose off the hose fitting (Figure 37).

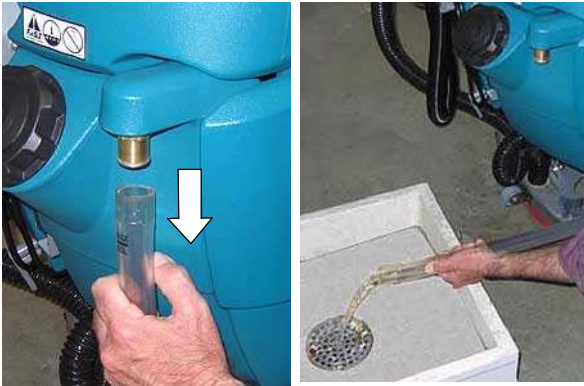

FIG. 37

2. To rinse out the solution tank remove the clean-out cap at the rear of the machine and spray water directly into the clean-out ports (Figure 38).



FIG. 38

3. Clean the solution tank filter (Figure 39).



FIG. 39

CHARGING BATTERIES

ATTENTION: To prolong the life of the batteries only recharge the batteries if the machine was used for a total of 30 minutes or more. Do not leave batteries discharged for lengthy periods.

⚠ WARNING: Fire Or Explosion Hazard. Batteries Emit Hydrogen Gas. Keep Sparks And Open Flame Away. Keep Battery Compartment Open When Charging.

FOR SAFETY: When servicing batteries, wear protective gloves and eye protection when handling batteries and battery cables. Avoid contact with battery acid.

BATTERY CHARGER SPECIFICATIONS:

- CHARGER TYPE:
 - FOR SEALED (Gel) BATTERIES
 - FOR WET (Lead acid) BATTERIES
- OUTPUT VOLTAGE - 24 VOLTS
- OUTPUT CURRENT - 20 AMPS
- AUTOMATIC SHUTOFF CIRCUIT
- FOR DEEP CYCLE BATTERY CHARGING

ON-BOARD BATTERY CHARGER SETTINGS:

If your machine is equipped with the on-board charger, the charger settings must be set for your battery type, Wet/lead acid or sealed/Gel, before charging. Failure to properly set will result in battery damage.

To determine your battery type, see battery label. Contact your battery supplier if not specified.

To verify what the charger is currently for, connect the charger cord into an electrical receptacle. The charger will display a sequence of codes. One of the codes will either read "GEL" or "Acid" (Figure 40).

GEL = Set for sealed/maintenance free batteries
 Acid = Set for wet/lead acid batteries



FIG. 40

To change the setting, unplug the charger, peel up the corner of the display label and set the switches accordingly (Fig. 41). The charger cord must be unplugged when resetting.



FIG. 41

USING THE ON-BOARD BATTERY CHARGER

IMPORTANT: Before charging, make sure that the charger setting is properly set for your battery type (See ON-BOARD CHARGER SETTINGS).

1. Transport the machine to a well-ventilated area.
2. Park the machine on a flat, dry surface. Turn the key off and set the parking brake, if equipped.
3. If charging wet (lead acid) batteries check the fluid level before charging (See BATTERY MAINTENANCE).
4. Prop up the recovery tank for ventilation (Figure 42).



FIG. 42

5. Connect the charger's AC power supply cord into a properly grounded receptacle (Figure 43).

NOTE: The machine will not operate when charging.



FIG. 43

6. The charger will display a sequence of codes once the cord is connected (Figure 44).

Three-digits + the following code:

- A = Charging current
- U = Battery Voltage
- h = Charging time
- C = Charging ampere-hours [Ah]
- E = Energy used [Kwh]

"GEL" or "Acid" = Battery type the charger is currently set for. Before charging make sure your battery type matches the display: GEL=Sealed, Acid=WET (lead acid). To change setting, see ON-BOARD CHARGER SETTINGS.

Press the arrow button to review the codes.



FIG. 44

7. Once the charging cycle begins, the indicator lights will progress from red, yellow to green. When the green indicator light comes on, the charging cycle is done. Unplug the charger cord.

If the charger detects a problem, the charger will display an error code (See ON-BOARD BATTERY CHARGER ERROR CODES).

ON-BOARD BATTERY CHARGER ERROR CODES

DISPLAY CODE	FAULT	SOLUTION
bat	Loose or damaged battery cable	Check battery cable connections.
	Battery exceeded maximum voltage level.	No action necessary.
E01	Exceeded maximum battery voltage allowed.	No action necessary.
E02	Safety thermostat exceeded maximum internal temperature.	Check if the charger vents are obstructed.
E03	Exceeded maximum time for charging phase leaving the batteries undercharged due to a sulfated or faulty battery.	Repeat the charging cycle and if the error code E03 reappears check battery or replace it.
SCt	Safety timer exceeded maximum charging time. Interrupts charging cycle.	Replace battery.
Srt	Possible internal short circuit.	Contact Service Center.

USING AN OFF-BOARD BATTERY CHARGER (OPTION)

1. Transport the machine to a well-ventilated area.
2. Park the machine on a flat, dry surface. Turn the key off and set the parking brake, if equipped.
3. If charging wet (lead acid) batteries, check the fluid level before charging (See BATTERY MAINTENANCE).
4. Prop up the recovery tank for ventilation (Figure 45).



FIG. 45

5. Connect the charger's AC power supply cord into a properly grounded receptacle.
6. Connect the charger's DC cord into the machine's battery receptacle (Figure 46).



FIG. 46

7. The supplied charger will automatically begin charging and shut off when fully charged.

NOTE: The machine will not operate when charging.

ATTENTION: Do not disconnect the charger's DC cord from the machine's receptacle when the charger is operating. Arcing may result. If the charger must be interrupted during charging, disconnect the AC power supply cord first.

ADJUSTING SCRUB HEAD BRUSHES

To ensure optimum scrubbing performance periodically check the scrub head for proper adjustment.

FOR SAFETY: Before adjusting scrub head, stop machine on level surface, remove key and set parking brake if equipped.

DISK MODEL

Tools required: Measuring device, 27mm wrench and 24mm wrench

1. With brushes installed, lower the scrub head and apply medium brush pressure.
2. Turn machine off and remove key.
3. From the center front and back of scrub head, measure the distance from the top edge of scrub head to the floor (Figure 47).



FIG. 47

4. If scrub head is not level, loosen the lock nut and turn the scrub head leveling screw to level. Tighten down the lock nut once head is level (Figure 48).



FIG. 48

CYLINDRICAL BRUSH MODEL

After installing a new set of cylindrical brushes check the brush pattern to ensure proper brush adjustment. Brushes that are not properly adjusted will result in premature wear and poor scrubbing performance (Figure 49).

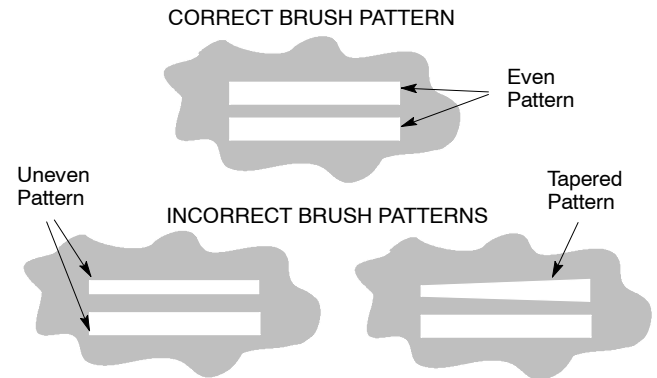

FIG. 49

To Inspect the Brush Pattern:

1. Position the machine on a dry dusty floor or apply a powdered substance, such as chalk.
2. Disconnect the drive motor wire connector to keep machine from moving forward (Figure 50).



FIG. 50

3. Lower the scrub head to the floor and apply maximum brush pressure.
4. Shut off the solution flow.
5. Pull the control handle bail to create a brush pattern on the floor.
6. Raise the scrub head and pull the machine away.
7. Observe the brush pattern on floor. If the brush pattern is uneven or tapered, adjustment is required.
8. Reconnect drive motor wire.

To Adjust an Uneven Brush Pattern:

Tools required: Measuring device, 27mm wrench and 24mm wrench

1. Measure the distance from the front edge of the scrub head to the floor and from the back edge of the scrub head to the floor (Figure 51). The measurements should be the same.



FIG. 51

2. To level the scrub head, loosen the lock nut and turn the leveling screw clockwise to lower the rear of the scrub head or counter-clockwise to lower the front (Figure 52).

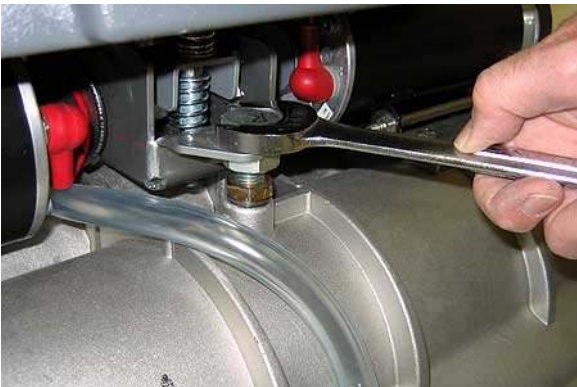

FIG. 52

3. Recheck brush pattern.

NOTE: Replace brushes when worn to 15mm.

To Adjust a Tapered Brush Pattern:

Tools required: 10mm wrench and 6mm hex wrench

1. Raise the scrub head off floor and remove key.
2. Remove the idler plate from the brush (Figure 53).



FIG. 53

3. Hold the brush plug shaft with a wrench and loosen the 6mm hex screw (Figure 54).

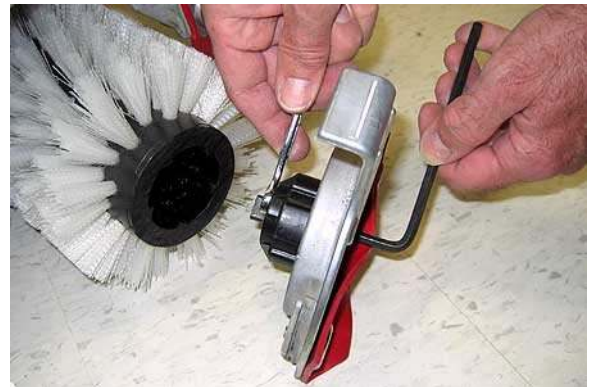

FIG. 54

4. To lower the brush end, turn the shaft clockwise for the front brush and counter-clockwise for the rear brush. Retighten hex screw (Figure 55).



FIG. 55

5. Recheck brush pattern.

NOTE: Replace brushes when worn to 15mm.

MACHINE MAINTENANCE

To keep the machine in good working condition, it's important that the following maintenance procedures are performed on a routine basis.

⚠ WARNING: Electrical Hazard. Disconnect Battery Cables Before Servicing Machine.

DAILY MAINTENANCE (After Every Use)

1. Drain the recovery tank (Figure 56).



FIG. 56

2. Rinse and clean out the recovery tank (Figure 57).



FIG. 57

3. Remove the recovery tank float shut-off screen and clean (Figure 58).



FIG. 58

4. Remove the debris tray and empty (Figure 59)



FIG. 59

5. Drain the solution tank (Figure 60).

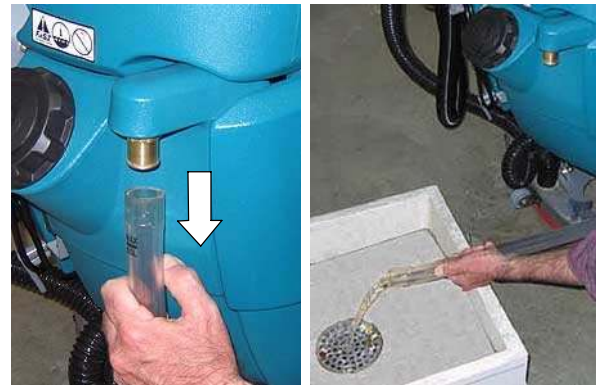

FIG. 60

6. Clean the solution tank filter (Figure 61).



FIG. 61

7. Rotate pad or replace when worn (Figure 62).

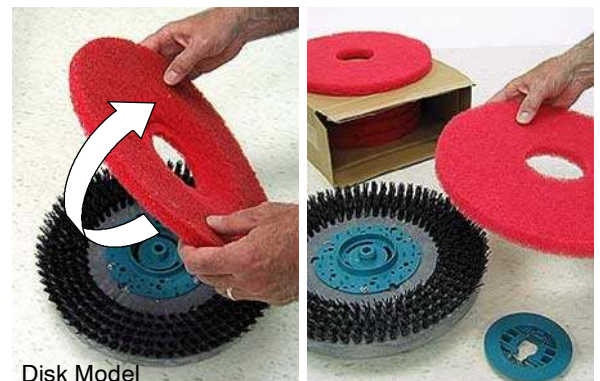

FIG. 62

8. Empty and rinse out the debris trough (Figure 63).

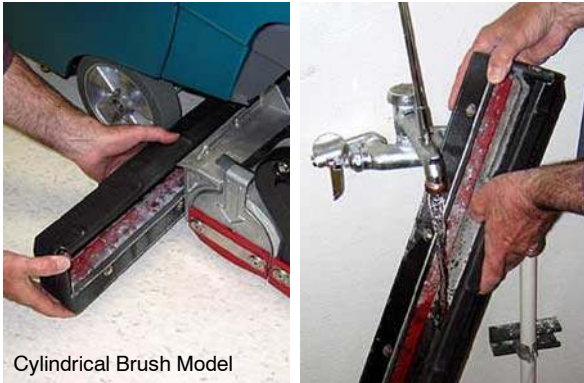

FIG. 63

9. Inspect the cylindrical brushes for wear. Rotate brushes from front-to-rear every 50 hours (Figure 64). Replace when worn to a length of 15mm.

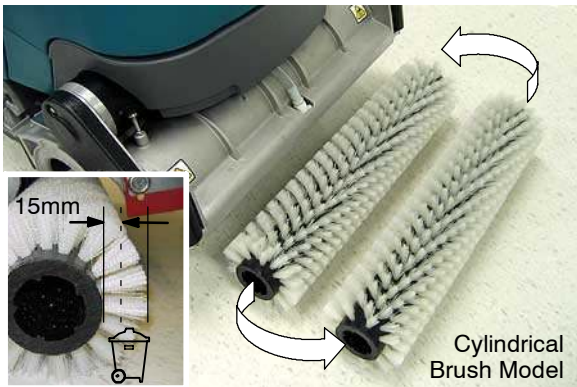

FIG. 64

10. Remove debris buildup from the underside of the cylindrical brush scrub head, including the idler plates and drive hubs (Figure 65).

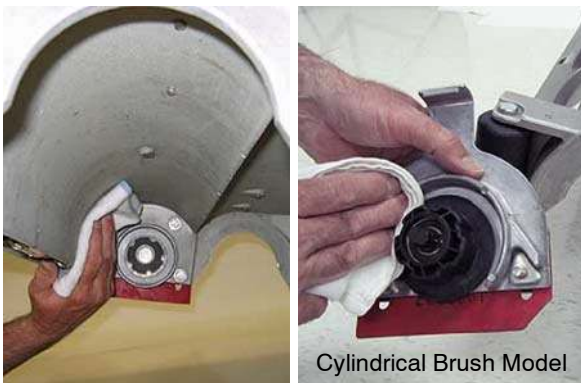

FIG. 65

11. Wipe the squeegee blades clean (Figure 66). Store the squeegee assembly in the raised position to prevent blade damage.



FIG. 66

12. Check the condition of the squeegee blade wiping edge (Figure 67). Rotate blade if worn (See SQUEEGEE BLADES).



FIG. 67

13. Clean the machine with an all purpose cleaner and damp cloth (Figure 68).

FOR SAFETY: When cleaning machine, do not power spray or hose off machine. Electrical malfunction may occur.



FIG. 68

14. Inspect the condition of the scrub head skirt, replace if worn or damaged (Figure 69).

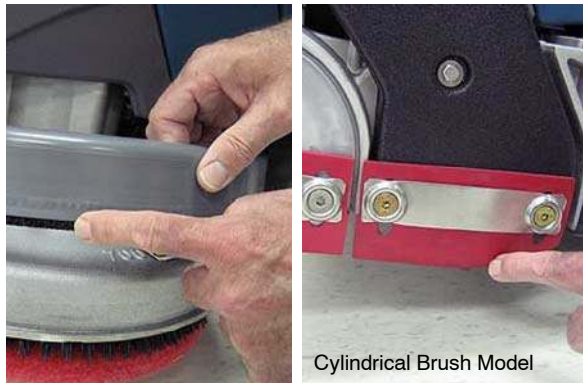

FIG. 69

15. FaST Model: Connect the FaST-PAK supply hose to the storage plug when not in use (Figure 70). Remove any dried concentrate from the hose connector by soaking it in warm water.

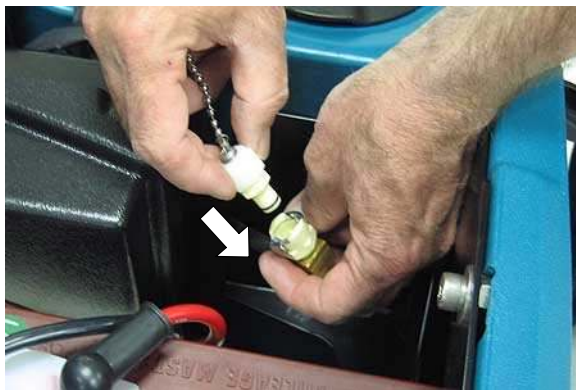

FIG. 70

16. Clean wet/lead acid batteries to prevent corrosion and check for loose battery cable connections (See BATTERY MAINTENANCE).
17. Recharge the batteries (Figure 71). To prolong the life of the batteries, only recharge the batteries if the machine was used for a total of 30 minutes or more.



FIG. 71

MONTHLY MAINTENANCE

1. Check the cylindrical brush belt tension every 100 hours (Figure 72). Belt tension should flex 3mm at midpoint, with 1.13-1.22 Kg force.

⚠ WARNING: Electrical Hazard. Disconnect Battery Cables Before Servicing Machine.

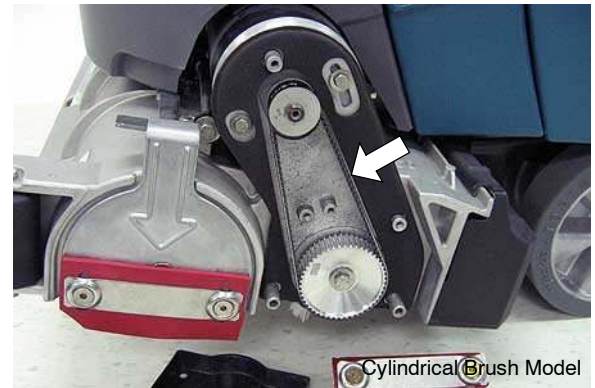

FIG. 72

2. Inspect and clean the recovery tank cover seal (Figure 73). Replace if damaged.



FIG. 73

3. Lubricate all pivot points and rollers with a water resistant grease.
4. Lubricate the casters with a water resistant grease (Figure 74).



FIG. 74

5. Clean the parking brake clamp with a cleaning solvent.
6. Check the machine for loose nuts and bolts.
7. Check the machine for leaks.

BATTERY MAINTENANCE (Wet/lead acid batteries)

1. Check battery fluid level frequently to prevent battery damage. The fluid should be at the level shown (Figure 75). Add distilled water if low. **DO NOT OVERFILL**, the fluid may expand and overflow when charging.



CORRECT BATTERY FLUID LEVEL:

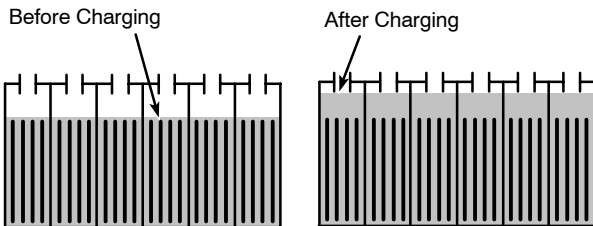

FIG. 75

⚠ WARNING: Fire Or Explosion Hazard. Batteries Emit Hydrogen Gas. Keep Sparks And Open Flame Away. Keep Battery Compartment Open When Charging.

2. Clean the batteries to prevent battery corrosion. Use a scrub brush with a mixture of baking soda and water (Figure 76).

FOR SAFETY: When cleaning batteries, wear protective gloves and eye protection. Avoid contact with battery acid.



FIG. 76

SQUEEGEE BLADES

When the blades become worn, simply rotate the blades end-for-end or top-to-bottom to a new wiping edge. Replace blades when all edges are worn.

The front blades on the 700mm/800mm squeegee assemblies have 12/14 slots on one edge and 6 slots on the opposite edge (Figure 77). If making sharp turns with the cylindrical brush models use the 12/14 slotted edge for maximum water pickup.

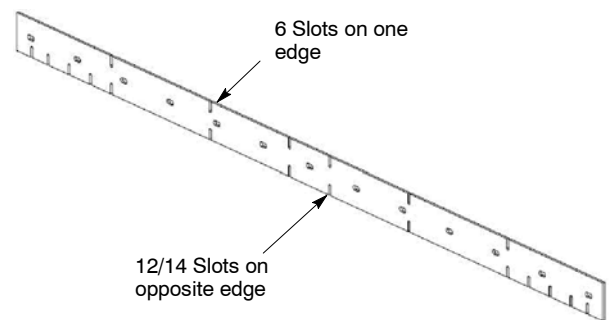

FIG. 77

Replacing Squeegee Blades:

1. Loosen the band clamp and remove the band from the squeegee assembly (Figure 78).

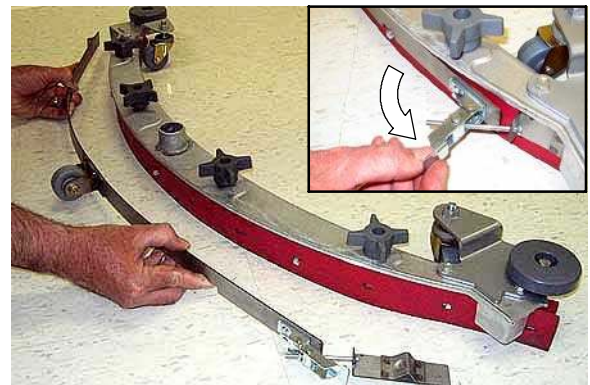

FIG. 78

2. Replace or rotate the rear blade to a new wiping edge and replace band (Figure 79).

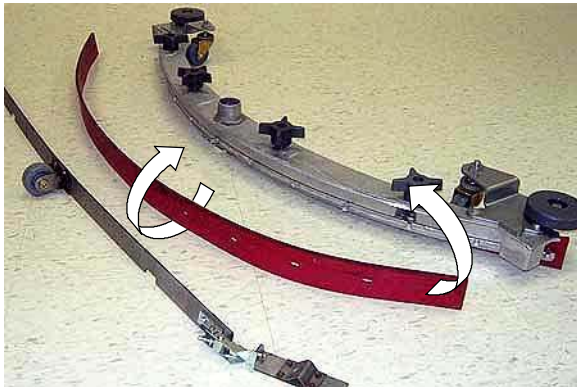

FIG. 79

3. To change the front blade, remove the band and loosen the four knobs. Replace or rotate the front blade to a new wiping edge (Figure 80).

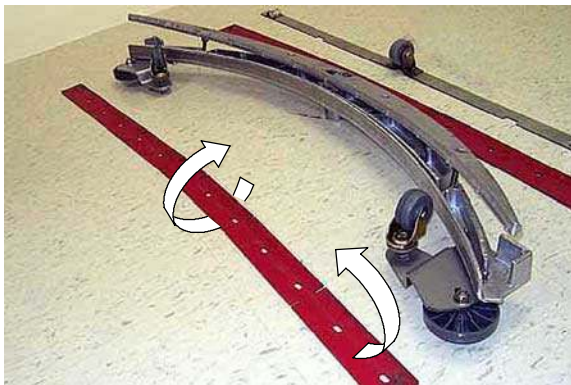

FIG. 80

MOTOR MAINTENANCE

Contact an Authorized Tennant Service Center for carbon brush replacement.

Carbon Brush Replacement	Hours
Drive Transaxle Motor	750
Vacuum Motor	
Disk Brush Motors	
Cylindrical Brush Motors	1000

⚠ WARNING: Electrical Hazard. Disconnect Battery Cables Before Servicing Machine.

FaST SYSTEM MAINTENANCE

Every 1000 hours replace the orifice plate and filter screen located inside the detergent injector assembly. Order service kit p/n 9001489.

1. To access the detergent injector assembly, lower the scrub head and remove the front shroud (Figure 81)

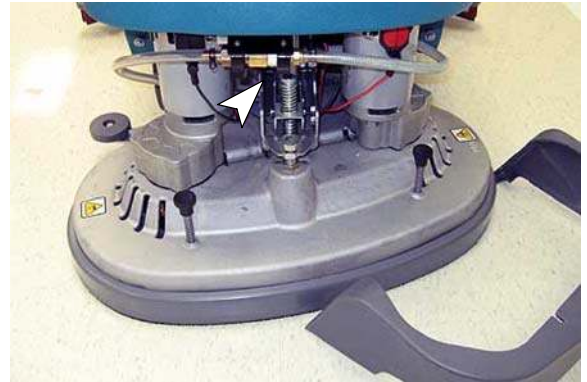

FIG. 81

2. Remove the injector assembly from clamps (Figure 82).



FIG. 82

3. Unthread the black plastic filter housing and replace the orifice plate and filter (Figure 83).

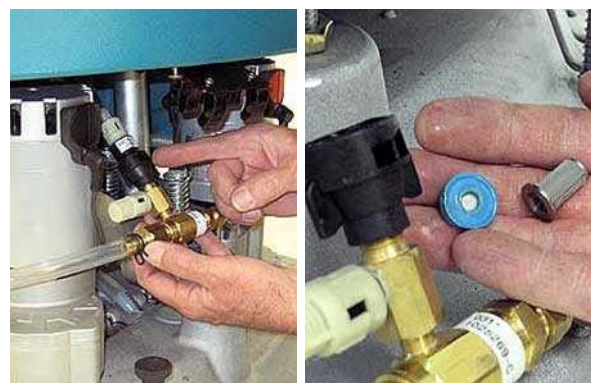

FIG. 83

JACKING UP MACHINE

Use the designated locations to jack up the machine for service (Figure 84). Empty the recovery and solution tank and position the machine on a level before jacking.

FOR SAFETY: When servicing machine, jack machine up at designated locations only. Use jack or hoist that will support machine weight.

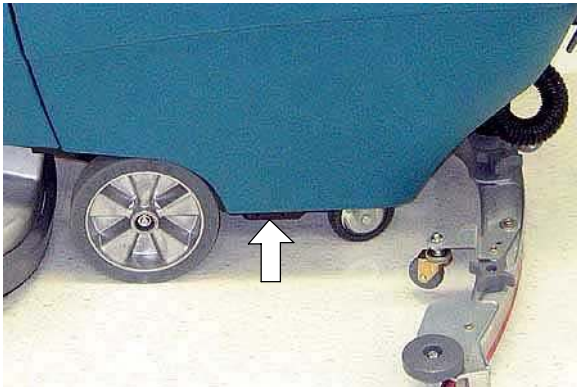

FIG. 84

TRANSPORTING MACHINE

When transporting the machine by trailer or truck, be certain to follow the transporting procedure below:

1. Drain machine tanks.
2. Load the machine using a ramp that can support the machine weight and person loading it. The maximum ramp incline should not exceed 11° at a ramp length of 3.7m.
3. Position the front of machine up against the front of the trailer or truck. Lower the scrub head and squeegee.
4. Set the parking brake, if equipped, and place a block behind each wheel to prevent the machine from rolling.
5. Secure with tie-down straps as shown (Figure 85). It may be necessary to install tie-down brackets to trailer or truck.

FOR SAFETY: When loading/unloading machine onto/off truck or trailer, use a ramp that can support the machine weight and person loading it, do not exceed a 11° ramp incline at a ramp length of 3.7m, use tie-down straps to secure machine and block machine wheels.

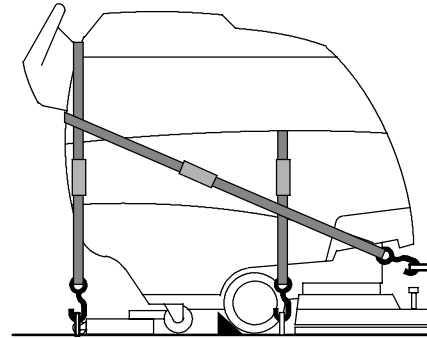

FIG. 85

STORING MACHINE

1. Charge the batteries before storing machine to prolong the life of the batteries.
2. Drain and rinse the tanks thoroughly.
3. Store the machine in a dry area with the squeegee and scrub head in the up position.
4. Open the recovery tank cover to promote air circulation.

ATTENTION: Do not expose machine to rain, store indoors.

5. If storing machine in freezing temperatures, make sure to drain machine of all water.

RECOMMENDED STOCK ITEMS

Refer to the Parts List Manual for recommended stock items. Stock Items are clearly identified with a bullet preceding the parts description. See example below:

26	1017380	(00000000-)	•	Hoist, Drain, Assy, 1.5d X 29.5l, Blk,Flx
27	1008639	(00000000-)	•	Drain Assy
28	1019563	(00000000-)	•	Strap, Drain Cap
29	1008637	(00000000-)	•	O Ring, 1.48" Id, 1.76" Od

TROUBLESHOOTING

PROBLEM	CAUSE	SOLUTION
Machine will not operate	Discharged batteries	Charge batteries
	Emergency-stop button activated	Turn button clockwise to reset
	Faulty battery(s)	Replace battery(s)
	Loose battery cable	Tighten loose cable
	Faulty control board	Contact Service Center
	Faulty key switch	Contact Service Center
	Machine fault detected.	See Control Panel Fault Indicator Codes
Onboard battery charger will not operate	Plug not connected to power supply	Check plug connection
	Faulty charger fuse	Replace charger fuse
	Faulty power supply cord	Replace cord
	Error detected.	See On-board Battery Charger Error Codes
Brush motor(s) will not operate	1-STEP scrub button is off	Turn on the 1-STEP scrub button
	Brush motor overload	See Control Panel Fault Indicator Codes
	Discharged batteries	Charge batteries
	Faulty control board	Contact Service Center
	Faulty scrub head (up/down) switch	Contact Service Center
	Faulty control handle bail switch	Contact Service Center
	Faulty brush motor or wiring	Contact Service Center
	Worn carbon brushes	Contact Service Center
	Broken or loose belt (cylindrical brush model)	Replace or tighten belt
Machine will not propel	Parking brake is set	Release parking brake lever
	Machine fault detected	See Control Panel Fault Indicator Codes
	Faulty control board	Contact Service Center
	Wheels raised off floor	Contact Service Center
	Faulty transaxle motor or wiring	Contact Service Center
	Worn carbon brushes	Contact Service Center
	Exceeded maximum incline	Avoid steep inclines and reset key
Vacuum motor will not operate	Squeegee is raised off floor	Lower squeegee
	Discharged batteries	Charge batteries
	Faulty control board	Contact Service Center
	Faulty vacuum motor or wiring	Contact Service Center
	Worn carbon brushes	Contact Service Center
Little or no solution flow	Solution tank is empty	Fill solution tank
	Clogged solution tank filter	Clean solution tank filter
	Discharged batteries	Charge batteries
	Clogged solution valve	Remove valve and clean
	Faulty control board	Contact Service Center

TROUBLESHOOTING - Continued

PROBLEM	CAUSE	SOLUTION
Poor water pickup	Recovery tank is full or excessive foam buildup	Drain recovery tank
	Loose drain hose cap	Tighten cap
	Clogged float shut-off screen located in recovery tank	Clean screen
	Clogged squeegee assembly	Clean squeegee assembly
	Worn squeegee blades	Replace or rotate squeegee blades
	Incorrect Squeegee blade deflection	Adjust Squeegee blade height
	Loose vacuum hose connections	Secure hose connections
	Clogged vacuum hose	Remove clogged debris
	Damaged vacuum hose	Replace vacuum hose
	Recovery tank cover not in place	Properly position cover
	Damaged recovery tank cover seal	Replace seal
	Faulty vacuum motor	Contact Service Center
Poor scrubbing performance	Debris caught in brush	Remove debris
	Worn brushes/pads	Replace brushes/pads
	Incorrect brush pressure setting	Adjust pressure setting
	Wrong brush/pad type.	Use correct brush/pad
Reduced run time	Batteries not fully charged	Fully recharge batteries
	Defective batteries	Replace battery
	Batteries need maintenance	See BATTERY MAINTENANCE
	Faulty battery charger	Repair or replace battery charger
Solution flow and brush pressure buttons and FaST system switch are locked	Supervisor controls are activated (lockout feature)	Contact your Supervisor
FaST Model: FaST System does not operate or operate correctly	FaST system switch is not turned on	Turn on FaST system switch
	FaST-PAK supply hose not connected	Connect supply hose
	Clogged FaST-PAK supply hose or connectors	Soak in warm water to unclog
	Empty FaST-PAK carton	Replace FaST-PAK carton
	Kink in FaST-PAK supply hose	Undo hose kink
	Clogged FaST solution system	Contact Service Center
	Faulty FaST system on/off switch	Contact Service Center
	Faulty pump	Contact Service Center
	Clogged solution tank filter	Drain solution tank. remove solution tank filter, clean and reinstall
	Clogged detergent orifice/filter screen	Replace orifice/filter screen (See FaST SYSTEM MAINTENANCE)
	Clogged FaST solution inlet filter	Contact Service Center
Faulty control board	Contact Service Center	

CONTROL PANEL FAULT INDICATOR CODES

The control panel fault indicator lights will display the following codes when the machine detects a fault.

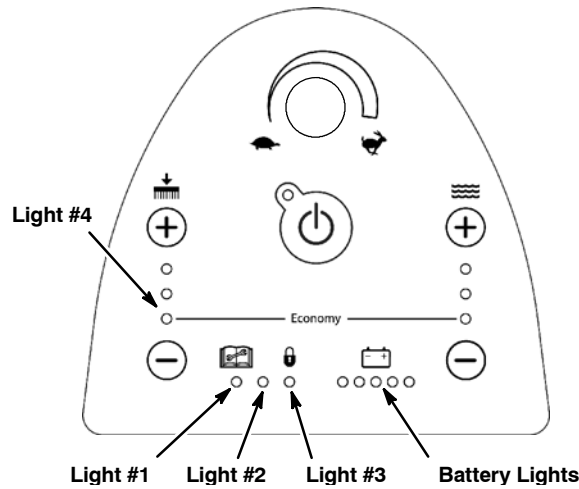

CODE	FAULT	SOLUTION
Light #1 blinks	Recovery tank is raised.	Lower recovery tank. Restart key to reset.
Lights #1, #2 and #3 ripple	Battery charger connected.	Disconnect battery charger. Restart key to reset.
Lights #1 and #4 blink	Left Brush motor overload.	Inspect brush for entangled debris, improper pad or contact service center. Restart key to reset.
Lights #3 and #4 blink	Right Brush motor overload.	Inspect brush for entangled debris, improper pad or contact service center. Restart key to reset.
Lights #2 and #3 blink	Propel motor overload. Exceeded maximum incline.	Avoid steep inclines or contact service center. Restart key to reset.
Lights #1 and #3 blink	Scrub head movement is obstructed or actuator motor malfunction.	Check scrub head for obstruction or contact service center. Restart key to reset.
Light #2 blinks	Vacuum motor malfunction.	Contact service center.
Lights #1 and #2 blink	Propel throttle malfunction.	Contact service center.
Light #3 blinks	FaST pump overload or malfunction.	Reset the 10A circuit breaker or contact service center. Restart key to reset.
Light #3 blinks when pressing the solution flow, brush pressure buttons and FaST system switch	Supervisor controls activated (lockout feature)	Contact your Supervisor.
Lights #1, #2 and #3 blink	Wand Pump overload or malfunction.	Reset the 10A circuit breaker button or contact service center. Restart key to reset.
All battery lights blink	Emergency-Stop button activated	Turn button clockwise to reset.
All battery lights ripple	Key turned on while bail was engaged.	Release the control handle start bail.

MACHINE SPECIFICATIONS

MODEL	Disk, 600 mm	Disk, 700 mm	Disk, 800 mm	Cylindrical, 650 mm	Cylindrical, 800 mm
LENGTH	1350 mm				
WIDTH	580 mm				
HEIGHT	1120 mm				
MINIMUM AISLE TURN	1346 mm	1499 mm	1626 mm	1575 mm	1638 mm
WEIGHT	143 kg	165 kg	171 kg	162 kg	166 kg
WEIGHT WITH BATTERIES	263 kg	276 kg	282 kg	281 kg	285 kg
RECOVERY TANK CAPACITY	102 L				
SOLUTION TANK CAPACITY	85 L				
DRIVE SYSTEM	Transaxle, 24 V, .19 kW				
TRAVEL SPEED, MAXIMUM	Cleaning: 67 m/min Transporting: 72 m/min				
PRODUCTIVITY RATE Theoretical	2450 m ² /h	2860 m ² /h	3270 m ² /h	2660 m ² /h	3270 m ² /h
PRODUCTIVITY RATE Estimated Actual	1660 m ² /h	1930 m ² /h	2230 m ² /h	1785 m ² /h	2230 m ² /h
CLEANING PATH WIDTH	600 mm	700 mm	800 mm	650 mm	800 mm
BRUSH DIAMETER	302 mm	353 mm	404 mm	151 mm	151 mm
BRUSH PRESSURE	18/36/54 kg				
SOLUTION FLOW RATE - Low:	1.70 L/min	1.90 L/min		1.70 L/min	1.90 L/min
SOLUTION FLOW RATE - Med:	1.30 L/min	1.51 L/min		1.30 L/min	1.51 L/min
SOLUTION FLOW RATE - Max:	.95 L/min	1.14 L/min		.95 L/min	1.14 L/min
SQUEEGEE WIDTH	908 mm standard 800 mm	1051 mm standard 908 mm	1185 mm standard 1051 mm	1051 mm	1185 mm
BRUSH MOTOR	Qty 2, .55kW, 220 rpm, 24 V, 29 A			Qty 2, .47 kW, 1500 rpm, 24V, 23 A	
VACUUM MOTOR	640 W, 3-stage 5.7, 24 V, 26 A				
WATER LIFT/AIR FLOW	5 5mm H ² O/ 32.4 L ³ /min				
BATTERIES	Qty 4, 6 V				
RUN TIME PER CHARGE	Minimum 3.5 h / Maximum 4.75 h				
BATTERY CAPACITY	WET (lead acid) = 180 Ah@ 5 h rate, 200Ah @ 5 h rate Sealed (Gel)= 180Ah @ 5 h rate				
ONBOARD CHARGER	230 VAC, 5 A, 50/60 Hz, 24 VDC, 20 A output				
TOTAL POWER CONSUMPTION	50 Amp nominal				
VOLTAGE DC	24 VDC				
PROTECTION GRADE	IPX3				
SOUND POWER LEVEL	79.5dB			81dB	
DECIBEL RATING AT OPERATOR'S EAR, INDOORS.	67dBA			68dBA	
VIBRATION AT CONTROLS	<.1188 m/s ²			<.103 m/s ²	
ACCELERATION RATE ON OPERATOR - MAX.	.179 m/s ²				
GRADE LEVEL, MAX.	Scrubbing 5% (3°), Transporting 8% (5°)				

FaST SYSTEM	Disk, 600 mm	Disk, 700 mm	Disk, 800 mm	Cylindrical, 650 mm	Cylindrical, 800 mm
PRODUCTIVITY RATE Estimated Actual	1865 m ² /h	2115 m ² /h	2440 m ² /h	1950 m ² /h	2440 m ² /h
SOLUTION PUMP	24 Volt DC, 3.5 A, 5.6 L/min open flow, 4.13 Bar bypass setting				
SOLUTION FLOW RATE	0.57 L/min.	0.83 L/min.		0.57 L/min.	0.83 L/min.
CONCENTRATE FLOW RATE	0.57 CC/min.	0.83 CC/min.		0.57 CC/min.	0.83 CC/min.
CONCENTRATE TO WATER DILUTION RATIO	1:1000				

MACHINE DIMENSIONS

