

Clemas & Co Ltd

Industrial Cleaning Equipment
Sales - Hire - Service

TENNANT R3 CARPET CLEANER OPERATOR MANUAL



Clemas & Co. Unit 5 Ashchurch Business Centre, Alexandra Way, Tewkesbury,
Gloucestershire, GL20 8NB.

Tel: 01684 850777

Fax: 01684 850707

Email: info@clemas.co.uk

Web: www.clemas.co.uk

This manual is furnished with each new model. It provides necessary operation and maintenance instructions.

Read this manual completely and understand the machine before operating or servicing it.

A complete illustrated Parts Manual is also furnished with each new model. Use the Parts Manual to order replacement parts. To ensure prompt delivery, follow the "HOW TO ORDER PARTS" instructions printed in the Parts Manual.

This machine will provide excellent service. However, the best results will be obtained at minimum costs if:

- The machine is operated with reasonable care.
- The machine is maintained regularly - per the machine maintenance instructions provided.
- The machine is maintained with manufacturer supplied or equivalent parts.

UNCRATING MACHINE: Carefully check carton for signs of damage. Report damages at once to carrier.



PROTECT THE ENVIRONMENT

Please dispose of packaging materials and old machine components in an environmentally safe way according to local waste disposal regulations.



Always remember to recycle.

CE

This machine is in conformity with the following directives and standards:

- Machinery Directive: 98/37/EC
- EMC Directive: 89/336/EC, 91/263/EC, 92/31/EC, 93/67/EC and 93/68/EC
- Low Voltage Directive: 73/23/EC, 93/68/EC
- Harmonized Standards: EN 60335-2-68

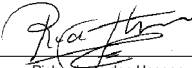

Richard van den Hoogen
Design and Development Management

MACHINE DATA

Please fill out at time of installation for future reference.

Model No. - _____

Serial No. - _____

Machine Options - _____

Sales Rep. - _____

Sales Rep. phone no. - _____

Customer Number - _____

Installation Date - _____

TABLE OF CONTENTS

SAFETY PRECAUTIONS	3
GROUNDING INSTRUCTIONS	4
SAFETY LABELS	4
MACHINE COMPONENTS	5
MACHINE APPLICATION	6
MACHINE SETUP	6
INSTALLING ROLLERS	6
FILLING SOLUTION TANK	6
CONNECTING POWER CORD	7
MACHINE OPERATION	7
PRE-OPERATION	7
CLEANING CARPETS	8
CLEANING WITH ACCESSORY TOOLS (Option)	9
MACHINE MAINTENANCE	10
AFTER EACH USE	10
AFTER EVERY 10 HOURS OF USE	11
AFTER EVERY 100 HOURS OF USE	11
BRUSH MOTOR MAINTENANCE	11
STORING MACHINE	11
RECOMMENDED STOCK ITEMS	12
TROUBLESHOOTING	12
MACHINE SPECIFICATIONS	13

SAFETY PRECAUTIONS

This machine is intended for commercial use. It is designed exclusively to clean carpet and upholstery in an indoor environment and is not constructed for any other use. Use only manufacturer's recommended attachments.

All operators must read, understand and practice the following safety precautions.

The following warning alert symbol and the "FOR SAFETY" heading are used throughout this manual as indicated in their description:

⚠ WARNING: To warn of hazards or unsafe practices which could result in severe personal injury or death.

FOR SAFETY: To identify actions which must be followed for safe operation of equipment.

The following safety precautions signal potentially dangerous conditions to the operator or equipment.

⚠ WARNING: Fire Or Explosion Hazard

- Do Not Use or Pick Up Flammable Materials
- Only Use Commercially Available Floor Cleaners intended for machine application.
- Do Not Use Near Flammable Liquids, Vapors Or Combustible Dusts.

This machine is not equipped with explosion proof motors. The electric motors will spark upon start up and during operation which could cause a flash fire or explosion if machine is used in an area where flammable vapors/liquids or combustible dusts are present.

⚠ WARNING: Electrical Hazard

- Do Not Operate With Damaged Power Cord.
- Do Not Modify Power Cord Plug.
- Unplug Power Cord Before Servicing Machine.

If the power cord is damaged or broken, it must be replaced by the manufacturer or its service agent or a similarly qualified person in order to avoid a hazard.

⚠ WARNING: Spinning Brush. Keep Hands Away. Unplug Power Cord Before Servicing Machine.

⚠ WARNING: Electrical Shock Hazard. Do Not Use Outdoors. Do Not Expose To Rain. Store Indoors.

FOR SAFETY:

1. Do not operate machine:
 - Unless trained and authorized.
 - Unless operator manual is read and understood.
 - In an area where flammable vapors/liquids or combustible dusts are present.
 - Unless power cord is properly grounded. Only use the manufacturer-supplied power cord which is designed exclusively for this machine. Do not use additional extension cords.
 - Outdoors.
 - If not in proper operating condition.
 - In standing water.
2. Before operating machine:
 - Make sure all safety devices are in place and operate properly.
 - Place wet floor signs as needed.
3. When operating machine:
 - Do not run machine over power cord.
 - Do not pull machine by plug or power cord.
 - Do not pull power cord around sharp edges or corners.
 - Do not unplug by pulling on power cord.
 - Do not stretch power cord.
 - Do not handle plug with wet hands.
 - Keep power cord away from heated surfaces.
 - Report machine damage or faulty operation immediately.
 - Do not allow children to play on or around machine.
 - If foam or liquid begins to leak from machine, immediately shut off machine.
4. Before leaving or servicing machine:
 - Turn off machine.
 - Unplug power cord from wall outlet.
5. When servicing machine:
 - Unplug power cord from wall outlet.
 - Avoid moving parts. Do not wear loose jackets, shirts, or sleeves.
 - Do not power spray or hose off machine. Electrical malfunction may occur.
 - Use manufacturer-supplied or approved replacement parts.
 - All repairs must be performed by a qualified service person.
 - Do not modify the machine from its original design.
6. When transporting machine:
 - Unplug power cord from wall outlet.
 - Get assistance when lifting machine.
 - Do not wheel up or down stairs.
 - Use tie-down straps to secure machine to truck or trailer.

GROUNDING INSTRUCTIONS

This machine must be grounded. If it should electrically malfunction, grounding provides a path of least resistance for electrical current to reduce the risk of electrical shock. This machine is equipped with a power cord having an equipment-grounding conductor and grounding plug. The plug must be plugged into an appropriate outlet that is properly installed in accordance with all local codes and ordinances.

⚠ WARNING: Improper connection of the equipment-grounding conductor can result in a risk of electric shock. Check with a qualified electrician or service person if you are in doubt as to whether the outlet is properly grounded. Do not modify the plug provided with the machine. If it will not fit the outlet, have a proper outlet installed by a qualified electrician.

SAFETY LABELS

The safety labels appear on the machine in the locations indicated. Replace labels if they are missing or become damaged or illegible.



FOR SAFETY:
Read Manual before Operating Machine



⚠ WARNING: Electrical Hazard. Do not use with damaged cord. Unplug cord before servicing.



⚠ WARNING: Spinning brush. Keep hands away. Unplug power cord before servicing machine.



⚠ WARNING: Fire or Explosion Hazard. Do not use flammable liquids. Do not pick flammable liquids

MACHINE COMPONENTS

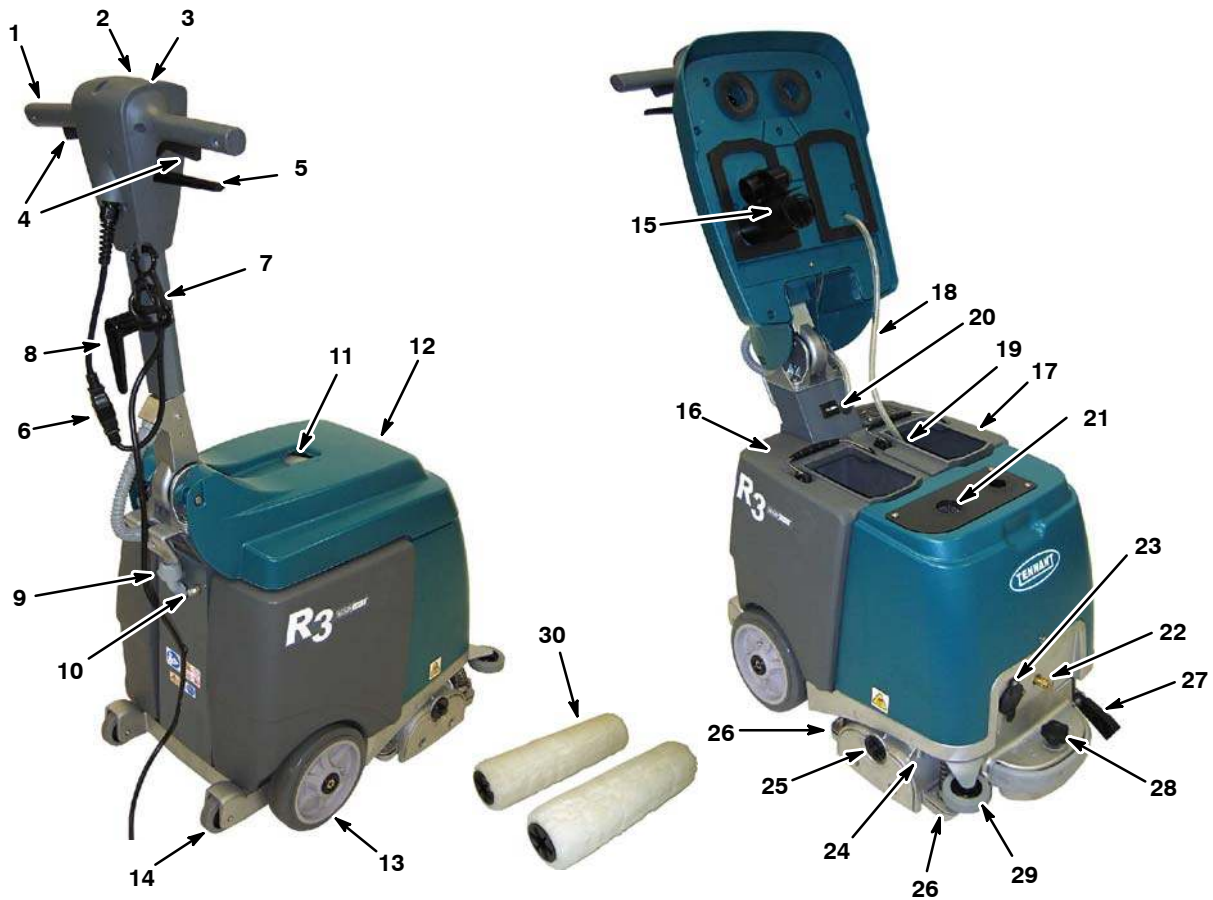

- | | |
|---|--|
| <ul style="list-style-type: none"> 1. Adjustable Control Handle 2. Main Power ON/OFF Switch 3. Roller Pressure Meter 4. Start Triggers 5. Handle Adjustment Lever 6. 15 m Power Cord 7. Power Cord Strain Relief Clip 8. Power Cord Hook 9. 7.5A Machine Circuit Breaker Button 10. 2.5A Brush Circuit Breaker Button 11. Recovery Window 12. Tank Cover 13. Main Wheels 14. Curb Climbing/Tilt Wheels 15. Vacuum Shut-Off Float | <ul style="list-style-type: none"> 16. Recovery Tank 17. Solution Tank 18. Solution Hose 19. Solution Hose Screen 20. Hour meter 21. Vacuum intake Screen 22. Accessory Tool Solution Hose Coupler 23. Accessory Tool Vacuum Hose Port 24. Scrub Head 25. Roller Idler Plate Locking Knob 26. Vacuum Shoes 27. Support Stand 28. Roller Pressure Adjustment Knob 29. Bumper Wheel 30. Rollers |
|---|--|

SWITCH SYMBOLS

- Power On
 Power Off
 + Vacuum

MACHINE APPLICATION

Use this machine to clean visible surface soils on a daily basis or as needed to maintain a high level of carpet cleanliness. The machine may be used during normal business hours because often the carpet is dry in less than 30 minutes.

If the carpet is heavily soiled, have the carpet deep cleaned first before using this machine for routine surface cleaning.

MACHINE SETUP

INSTALLING ROLLERS

FOR SAFETY: Before installing rollers, turn off machine and unplug power cord from wall outlet.

1. Raise the scrub head off the floor with the support stand and remove the roller idler plate (Figure 1). Turn the idler plate locking knob counter-clockwise to remove.



FIG. 1

2. Connect the two rollers to the drive hubs (Figure 2).

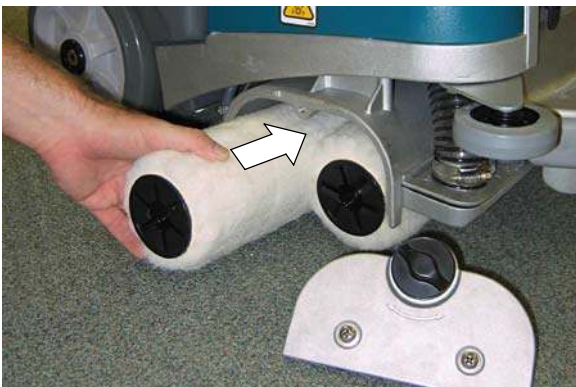

FIG. 2

3. Connect the idler plate to the rollers and reinstall the idler plate. Make sure the idler plate hooks engage the scrub head and that the locking knob is secure (Figure 3).



FIG. 3

NOTE: If storing the machine for an extended period, raise the scrub head with kick stand to prevent a flat spot in rollers.

FILLING SOLUTION TANK

1. Lift the cover and remove the solution tank from the machine (Figure 4).
2. Fill the solution tank with 19 L of clean water (50°C maximum temperature) (Figure 5). Partially fill if unable to lift a full tank.

ATTENTION: Do not add any cleaning detergents to solution tank. Cleaning detergent must be pre-sprayed on the carpet with the use of a pump-up sprayer.



FIG. 4

FIG. 5

ATTENTION: Do not use the recovery tank to fill the solution tank. Dirt from the recovery tank may cause damage to the solution pump.

⚠ WARNING: Fire Or Explosion Hazard, Do Not Use or Pick Up Flammable Materials.

- Submerge the solution hose screen into the solution tank and close the cover (Figure 6).



FIG. 6

CONNECTING POWER CORD

- Plug the supplied power cord into the machine and attach the power cord to the strain relief clip as shown (Figure 7).

FOR SAFETY: Do not operate machine unless power cord is properly grounded. Only use the manufacturer-supplied power cord which is designed exclusively for this machine. Do not use additional extension cords.

- Plug the power cord into a properly grounded wall outlet (Figure 8).



FIG. 7

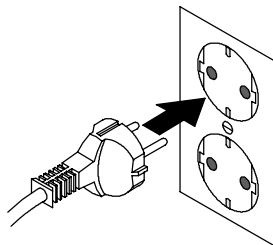

FIG. 8

⚠ WARNING: Electrical Hazard, Do Not Operate With Damaged Power Cord.

If the power cord is damaged or broken, it must be replaced by the manufacturer or its service agent or a similarly qualified person in order to avoid a hazard.

- Wrap the power cord around the handle and cord hook when storing machine. To remove power cord, turn the cord hook upward (Figure 9).



FIG. 9

MACHINE OPERATION

FOR SAFETY: Do not operate machine unless operator manual is read and understood.

PRE-OPERATION

- Inspect power cord for damage.
- Vacuum the carpet and remove debris from area.
- Using a pump-up sprayer, spray the carpet with an approved pre-treatment detergent (Figure 10).

Contact your dealer for recommended cleaning detergents.



FIG. 10

⚠ WARNING: Fire Or Explosion Hazard. Do Not Use Flammable Materials. Only Use Commercially Available Floor Cleaners intended for machine application.

CLEANING CARPETS

⚠ WARNING: Fire or Explosion Hazard, Do Not Use or Pick Up Flammable Materials.

1. Pull the handle adjustment lever and adjust the handle to a comfortable operating height (Figure 11). Release the lever to lock the position.



FIG. 11

2. Press the main power switch to the on (I) position (Figure 12).



FIG. 12

3. To prepare the rollers for cleaning, tip the machine back to the rear tilt wheels and pull the start triggers for approximately 30 seconds to wet the rollers (Figure 13).

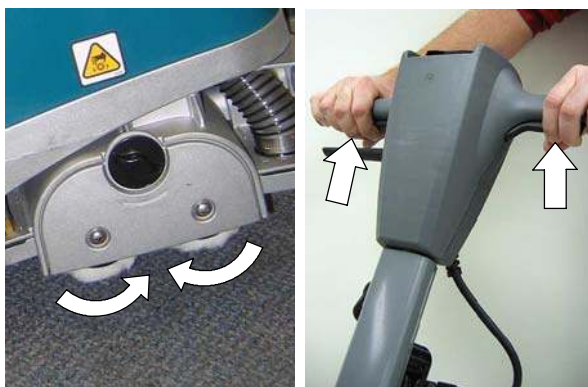

FIG. 13

4. To begin cleaning, pull the start triggers and slowly push the machine forward. You can also pull the machine backwards to clean (Figure 14).



FIG. 14

FOR SAFETY: When operating machine, do not run machine over power cord.

5. Observe the roller pressure meter. The meter should read in the green zone. Turn the roller pressure knob to adjust (Figure 15).

NOTE: For a new set of rollers the meter may read in the red zone for a short time until the rollers are broke in.

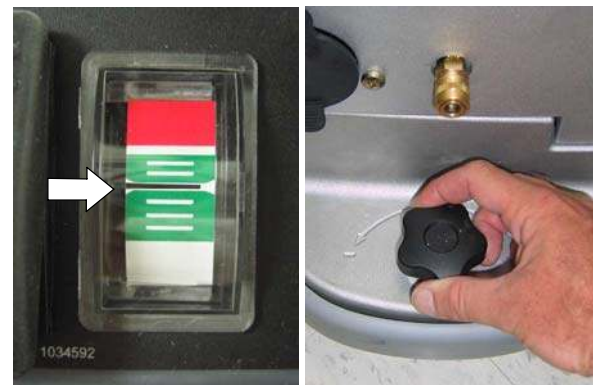

FIG. 15

6. The roller motor circuit breaker may trip if the rollers are set too low or if the rollers are obstructed. To reset the circuit breaker, unplug the power cord, determine cause and reset the 2.5 amp circuit breaker button (Figure 16).

FOR SAFETY: Before removing an obstruction from the rollers unplug power cord from wall outlet.

FOR SAFETY: When operating machine, if foam or liquid begins to leak from machine, immediately shut off machine.



FIG. 16

- View the water pickup from the recovery window (Figure 17). When the water pickup stops, unplug the power cord and empty the recovery tank.

The machine is equipped with a vacuum shut-off float that will automatically stop the water pickup when the recovery tank reaches the full point. A sudden change in vacuum motor sound will occur.



FIG. 17

ATTENTION: Check for excessive foam in the recovery tank. Empty tank if excessive. Foam may not activate the shut-off float which may result in vacuum motor damage.

- When transporting machine, roll the machine on both the main and rear tilt wheels.

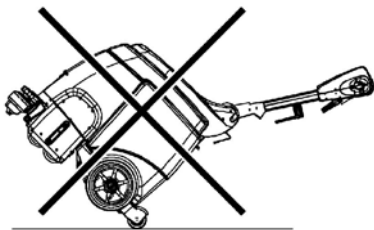

FOR SAFETY: When transporting machine, do not wheel up or down stairs.

CLEANING WITH ACCESSORY TOOLS (Option)

- Connect the accessory tool hoses to solution hose coupler and vacuum hose port located at the front of the machine (Figure 18).



FIG. 18

- Fill the solution tank (See FILLING SOLUTION TANK on page 6).
- Press the main power switch to the on (I) position (Figure 19).



FIG. 19

- Operate the accessory tool (Figure 20).

⚠ WARNING: Fire or Explosion Hazard, Do Not Use or Pick Up Flammable Materials.



FIG. 20

MACHINE MAINTENANCE

To keep the machine in good working condition, simply follow the machine's maintenance procedures.

FOR SAFETY: Before performing maintenance procedures turn off machine and unplug power cord from wall outlet.

ATTENTION: Contact an Authorized Service Center for machine repairs.

AFTER EACH USE

1. Wipe clean the power cord and inspect it for damage (Figure 21). Wrap power cord around handle and cord hook when not in use (Figure 22).



FIG. 21



FIG. 22

⚠ WARNING: Electrical Hazard, Do Not Operate With Damaged Power Cord.

If the power cord is damaged or broken, it must be replaced by the manufacturer or its service agent or a similarly qualified person in order to avoid a hazard.

2. Empty the recovery and solution tanks and thoroughly rinse with clean water (Figure 23).



FIG. 23

3. Clean the vacuum shut-off float (Figure 24) and the vacuum intake screen of any debris buildup (Figure 25).



FIG. 24



FIG. 25

4. Clean the solution hose screen (Figure 26).



FIG. 26



5. Clean the machine with an all purpose cleaner and damp cloth (Figure 27).



FIG. 27

AFTER EVERY 10 HOURS OF USE

1. Flip the rollers end for end (Figure 28). Replace the rollers after 100 hours of use.

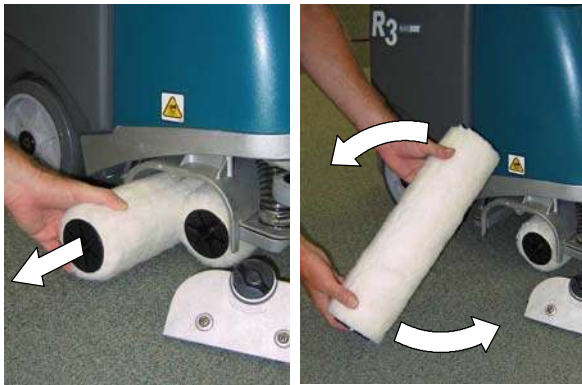

FIG. 28

2. Remove and clean the front and rear vacuum shoes of any debris (Figure 29). To remove the vacuum shoes, unthread the vacuum shoe knob.

FOR SAFETY: Before tipping machine back, unplug power cord from wall outlet.



FIG. 29

3. Remove any debris buildup from the underside of the scrub head (Figure 30).

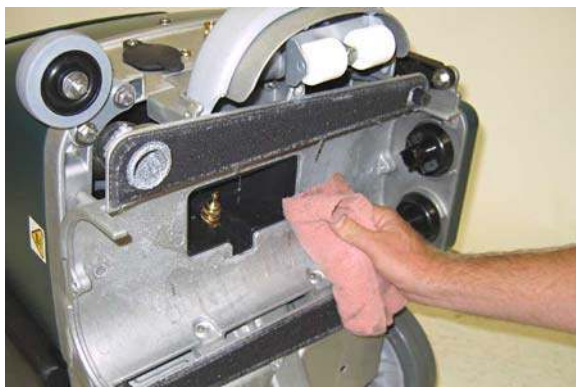

FIG. 30

AFTER EVERY 100 HOURS OF USE

1. Replace the rollers. Always replace rollers as a set.
2. Flush the solution system with white vinegar to remove any mineral deposits. Pour 2.2 L of white vinegar into the solution tank and operate the machine for 1-2 minutes, then let vinegar sit for up to six hours. Rinse solution system with water. Remove rollers before flushing.
3. Remove the spray tip and soak in white vinegar to prevent clogging. Do not use a pointed object to clean out spray tip, damage will occur (Figure 31).

FOR SAFETY: Before tipping machine back, unplug power cord from wall outlet.

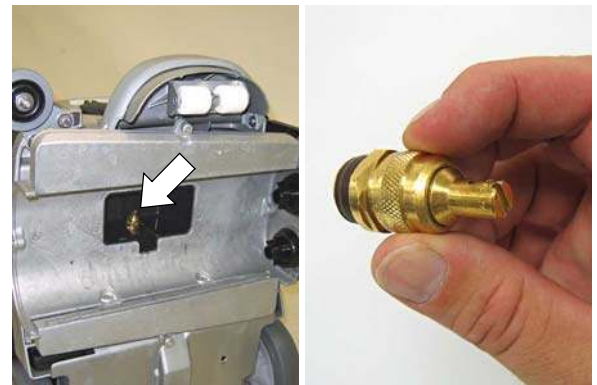

FIG. 31

BRUSH MOTOR MAINTENANCE

Contact an Authorized Service Center for carbon brush replacement.

Carbon Brush Replacement	Hours
Roller Motor	500

STORING MACHINE

Empty tanks and store the machine in a dry area in the upright position. Raise the scrub head with support stand to prevent a flat spot in rollers. Neatly wrap power cord around handle and cord hook.

If storing machine in freezing temperatures, purge solution system and pump from all water.

⚠ WARNING: Electrical Shock Hazard. Do Not Use Outdoors. Do Not Expose To Rain. Store Indoors.

RECOMMENDED STOCK ITEMS

Refer to the Parts List Manual for recommended stock items. Stock Items are clearly identified with a bullet preceding the parts description. See example below:

26	1017380	(00000000-)	•	Hose, Drain, Assy, 1.5d X 29.5l, Blk,Flx
27	1008639	(00000000-)	•	Drain Assy
28	1019563	(00000000-)	•	Strap, Drain Cap
29	1008637	(00000000-)	•	O Ring, 1.48" Id, 1.76" Od

TROUBLESHOOTING

PROBLEM	CAUSE	SOLUTION
Machine does not operate.	Faulty power cord.	Replace power cord.
	Tripped circuit breaker.	Unplug power cord and determine cause. Reset 7.5 amp circuit breaker button. Contact Service Center if circuit breaker continues to trip.
Rollers do not spin	Tripped circuit breaker.	Readjust roller pressure knob. Reset 2.5 amp circuit breaker button.
		Unplug power cord and inspect rollers for obstruction. Reset 2.5 amp circuit breaker button.
	Broken brush belt.	Contact Service Center.
	Faulty roller motor or worn carbon brushes.	Contact Service Center.
Poor water pickup.	Loose accessory tool vacuum hose port cover.	Check vacuum hose port cover.
	Worn rollers	Replace rollers.
	Clogged shut-off float.	Clean debris from shut-off float.
	Clogged vacuum intake screen.	Clean debris from intake screen.
	Clogged vacuum shoes.	Clean debris from vacuum shoes.
	Clogged vacuum shoe hose.	Contact Service Center.
	Worn tank cover gaskets.	Replace gaskets.
Faulty vacuum motor.	Contact Service Center.	
Uneven or no spray.	Empty solution tank.	Refill solution tank.
	Clogged spray tip.	Clean or replace tip.
	Improper spray tip angle.	Adjust spray tip angle.
	Faulty spray tip.	Replace spray tip.
	Clogged solution hose screen.	Clean debris from solution tank screen.
	Damaged solution hose.	Contact Service Center.
Faulty solution pump.	Contact Service Center.	
Excessive foam/cream appears on the floor	Cleaning detergent was added to solution tank.	Drain and rinse out solution tank and refill with water only, do not add cleaning detergent.

MACHINE SPECIFICATIONS

MODEL	R3
LENGTH	749 mm with handle folded
WIDTH	485 mm
HEIGHT	709 mm with handle folded
WEIGHT	53 kg
SOLUTION TANK CAPACITY	19 L
RECOVERY TANK CAPACITY	19 L
PRODUCTIVITY RATE - AVG.	302 m ² /hr
CLEANING PATH WIDTH	380 mm
ROLLER PRESSURE	14.5 kg
ROLLER MOTOR	230V, .2 kW, .8 A, 450 brush rpm
VACUUM MOTOR	230V, .88 kW, 2-stage 5.7, 3.6 A
WATER LIFT-AIR FLOW	2,184 mm
SOLUTION PUMP	230V, 0.081 kW, 2-stage 5.7, 0.35 A
SOLUTION FLOW RATE	.76 L/min
VOLTAGE	230 AC
TOTAL POWER CONSUMPTION	5.5 A
POWER CORD LENGTH	15 m
DECIBEL RATING AT OPERATOR'S EAR, INDOORS*	69 dBA
PROTECTION GRADE	IPX3
VIBRATIONS AT CONTROLS	<1.8 m/s ²

MACHINE DIMENSIONS

