

Clemas & Co Ltd

Industrial Cleaning Equipment
Sales - Hire - Service

S3B WET & DRY VACUUM CLEANER PARTS MANUAL



Clemas & Co. Unit 5 Ashchurch Business Centre, Alexandra Way, Tewkesbury,
Gloucestershire, GL20 8NB.

Tel: 01684 850777

Fax: 01684 850707

Email: info@clemas.co.uk

Web: www.clemas.co.uk

Table of Contents

S2B - S3B

Car 01	3
Car 02	5
Container unit	7
Liquid kit	9
Filter group	11
Suction unit	13
Recommended Spare Parts	15

Car 01

S2B - S3B

16-09-2012

Part List ID

01

3

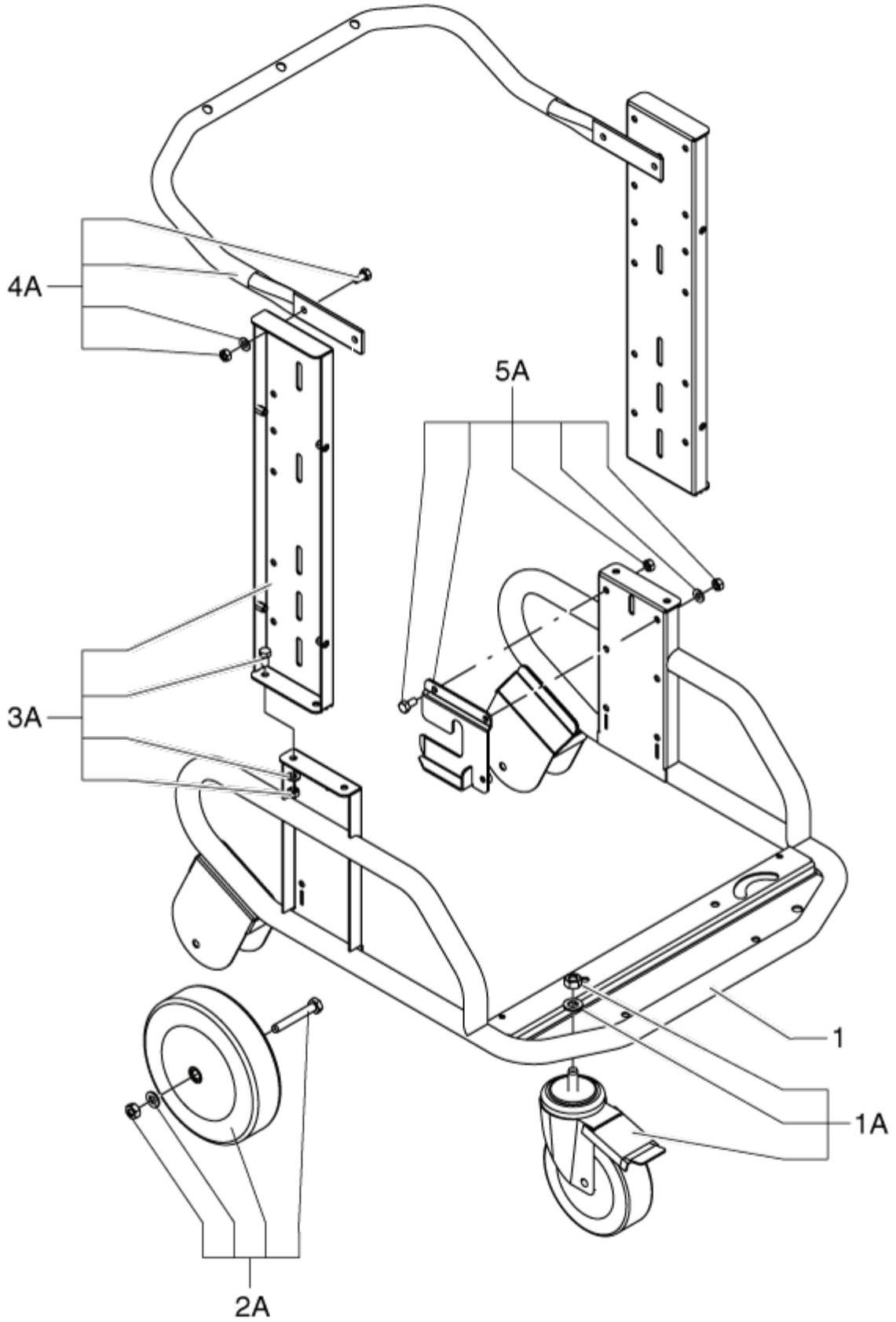

Car 01

S2B - S3B

16-09-2012

Part List ID U1

4

Pos	Part no.	Qty	Description
1	4083600611	1	TROLLEY FOR MODEL S2-S3 R7016
1A	40000874	1	KIT REVOLV. CASTOR D150
2A	40000873	1	WHEEL D200 KIT
3A	40000871	1	UPRIGHT KIT
4A	40000891	1	HANDLE KIT
5A	40000872	1	BIN RELEASE KIT

Car 02

S2B - S3B

16-09-2012

Part List ID

03

5

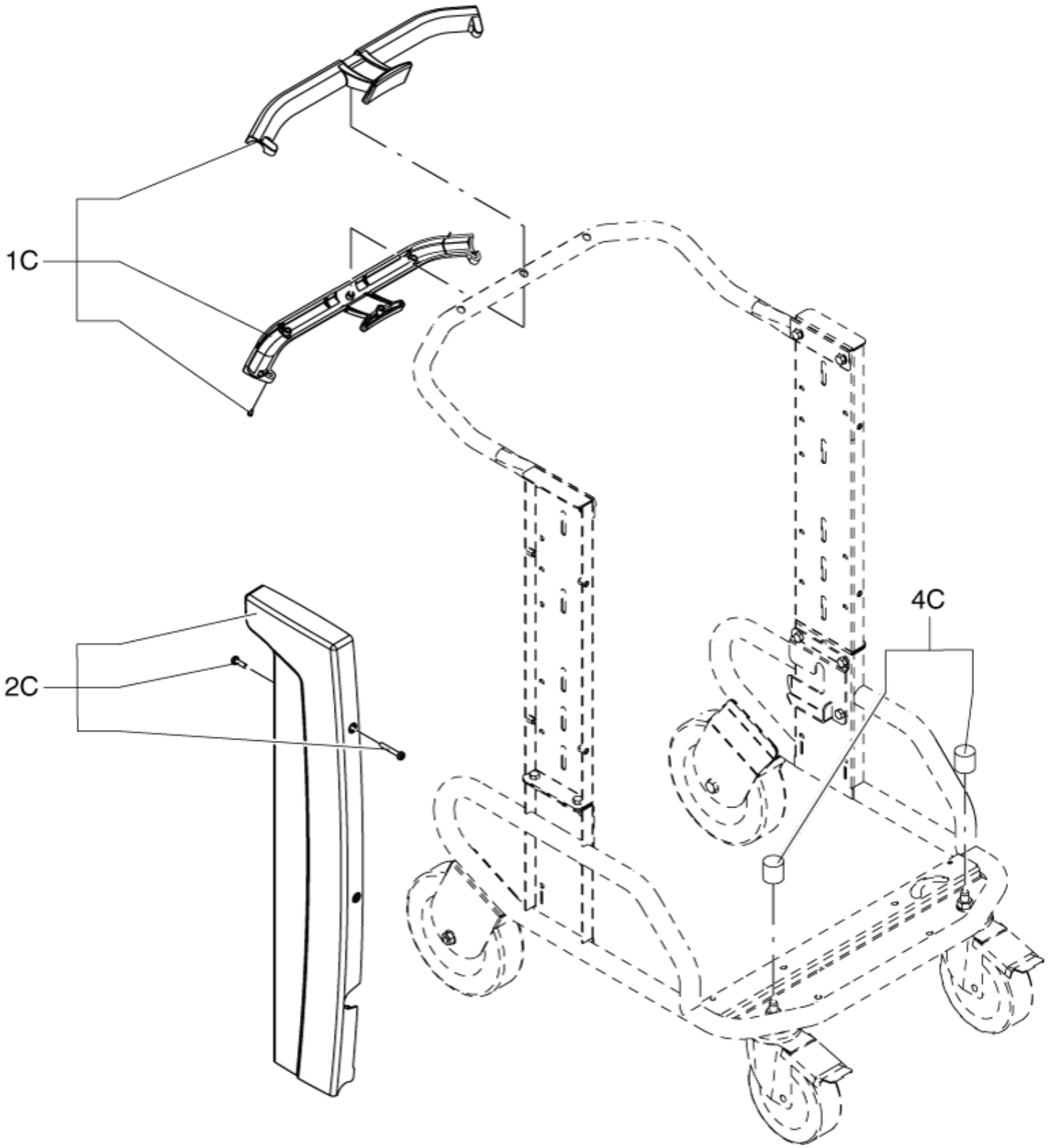

Car 02

S2B - S3B

16-09-2012

Part List ID U3

6

Pos	Part no.	Qty	Description
1C	40000855	1	HANDLE KIT
2C	40000864	1	UPRIGHT PROTECTION KIT
4C	40000870	1	PROTECTION KIT

Container unit

S2B - S3B

16-09-2012

Part List ID

05

7

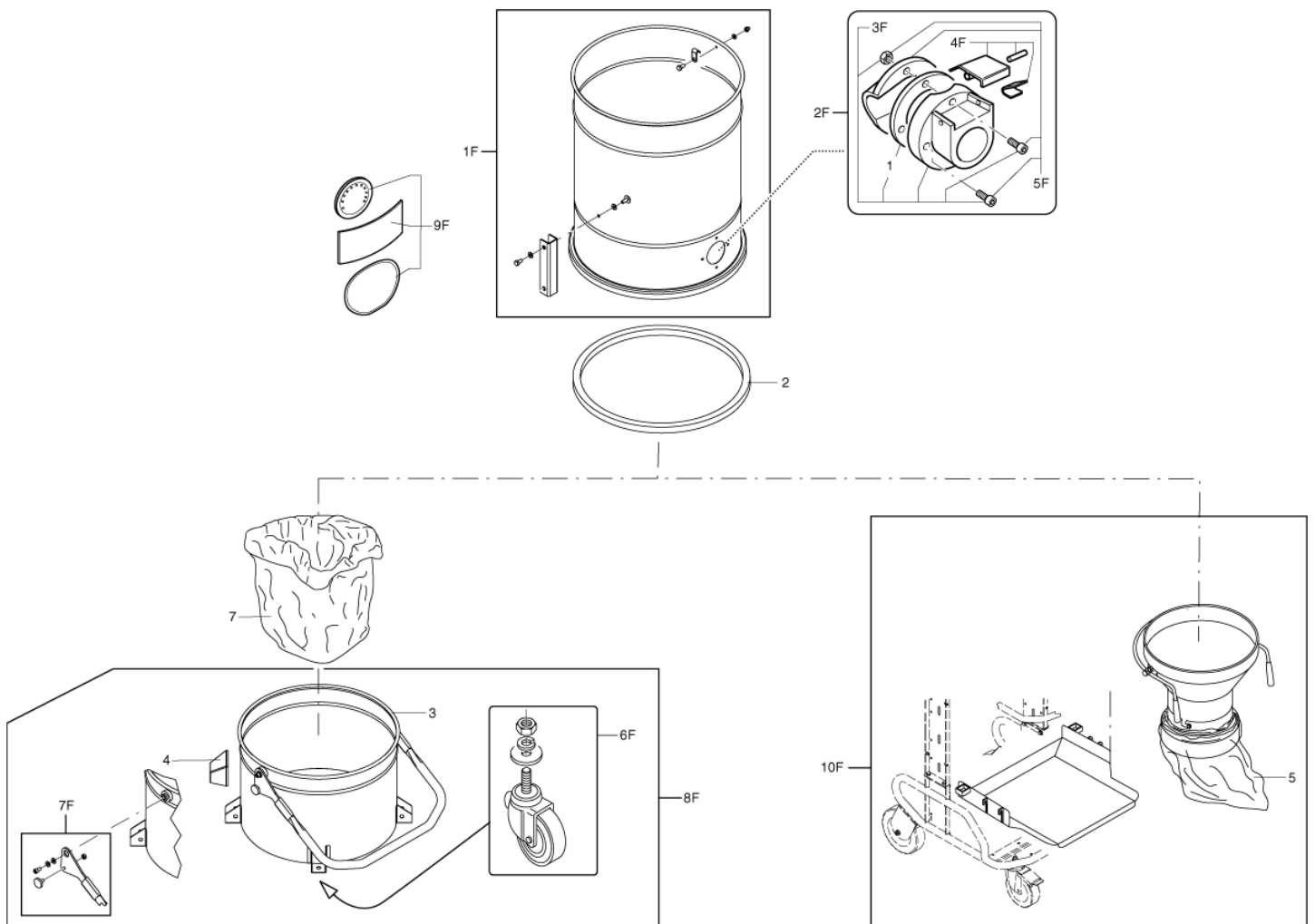

Container unit

S2B - S3B

16-09-2012

Part List ID

05

8

Pos	Part no.	Qty	Description
1	Z8 17006	1	INLET SEAL D70
2	40000762	1	SEAL
3	4083000493	1	BIN D460 L50 MODEL-S2-S3
3	4083000495	1	BIN D460 L100 FOR MODEL S3
3	4083000552	1	BIN D460 S3 L100 GRILL AND DEP
4	Z8 17021	4	BUMPER WHEEL HOLDER
5	4084000956	1	MINI PACKAGE 4x20 MT 55 MICRON LONGOPAC
5	4084001017	1	PACKAGE OF 5 BAGS D460 LDPE
7	Z8 40099	1	BAG POLYETHYLENE LDPE 3306
1F	40000869	1	FILTER CHAMBER KIT
2F	40000868	1	D70 INLET FULL KIT
3F	40000867	1	D70 INLET KIT
4F	40000345	1	KIT PUSHBUTTON FOR INLET D70
5F	40000395	1	KIT DEFLECTOR D70
6F	40000419	1	KIT CASTORS FOR CONTAINER
7F	40000866	1	HANDLE KIT L50
7F	40000879	1	HANDLE KIT L100
8F	4083000496	1	COMP.BIN D460 L50 M.S2-S3
8F	4083000497	1	COMP.BIN D460 L100 M.S3
8F	4083000555	1	COMPLETE BIN D460 L100 S3 F.DEPR
9F	40000944	1	STICKER KIT
10F	4056000468	1	DISCHARGE KIT MS2-S3-T30S

Liquid kit

S2B - S3B

16-09-2012

Part List ID

09

9

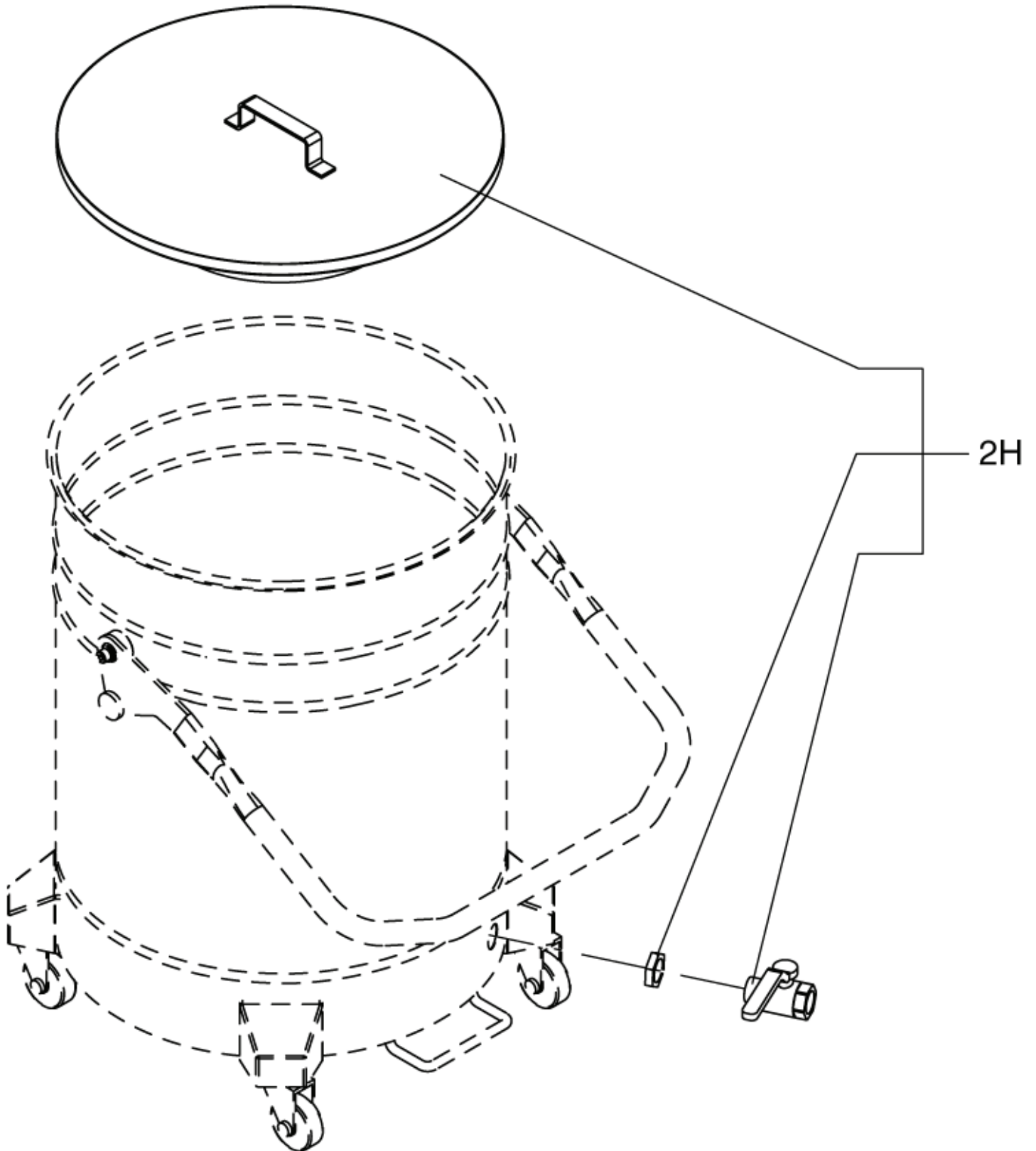

Liquid kit

S2B - S3B

16-09-2012

Part List ID 09

10

Pos	Part no.	Qty	Description
2H	Z5 60034	1	GRID AND VALVE D460 FE COMPLETE

Filter group

S2B - S3B

16-09-2012

Part List ID

11

11

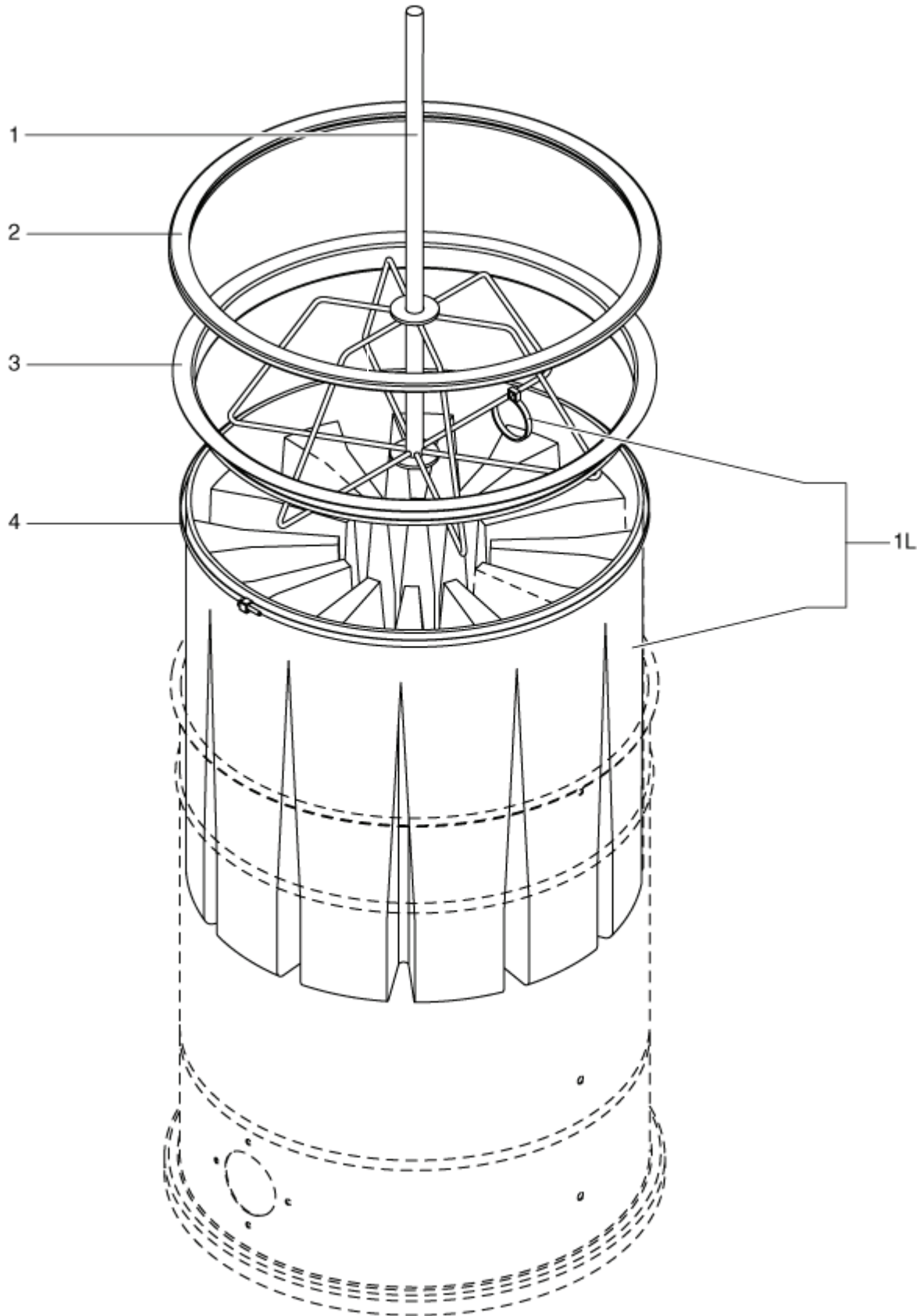

Filter group

S2B - S3B

16-09-2012

Part List ID

11

12

Pos	Part no.	Qty	Description
1	Z8 33093	1	STAR CAGE D460 MOD.317
1	Z8 33093 1	1	STAR CAGE D460 FILTER BIG SIZE
2	Z8 17026	1	FILTER SEAL D460 BLACK
2	Z8 17126	1	FILTER SEAL D460 SILIC.
3	Z8 15003	1	FILTER HOLDER RING D460 FE
3	Z8 15010	1	FILTER HOLDER RING D460 INOX
4	Z8 18079	1	FILTER BLOCK TIE D460
1L	40000338	1	KIT STAR FILTER D460 L CLASS
1L	40000699	1	18 POCKET STAR FILTER KIT M CLASS

Suction unit

S2B - S3B

16-09-2012

Part List ID

13

13

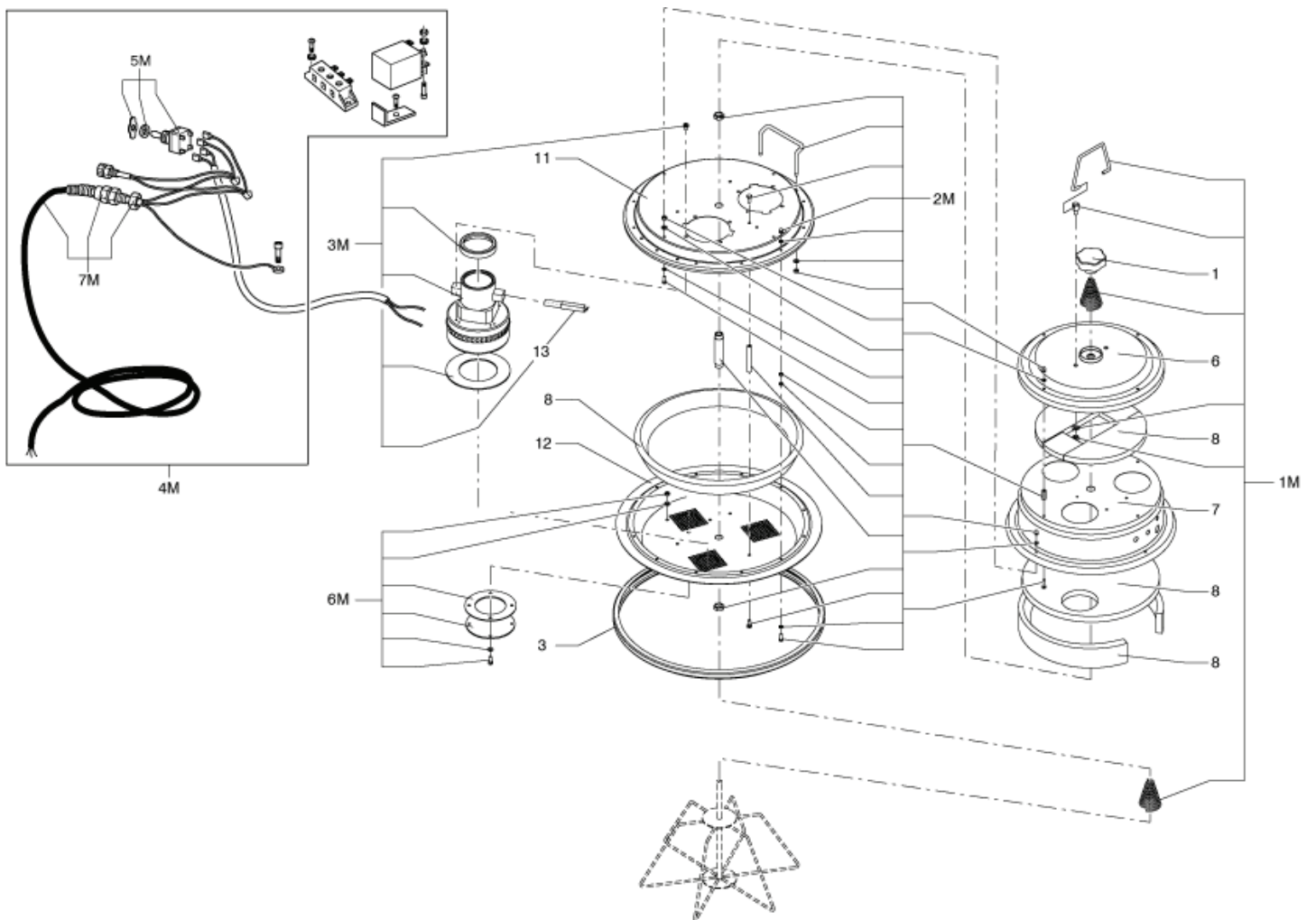

Suction unit

S2B - S3B

16-09-2012

Part List ID

13

14

Pos	Part no.	Qty	Description
1	Z8 40027	1	KNOB D70 M12 NO HOLE
3	Z8 36191	1	BAND LOCK D.460
6	4083500258	1	COVER 460 SC.M.S2/S3B R7016
7	Z8 16066	1	MOTOR COVER D460 2F
7	Z8 16067	1	HEADCOVER D460 3F
8	Z8 17229	1	KIT SOUNDPROOF D460 M.317
11	4081600597	1	FIX MOTOR FOR COVER D460 2F SC R7016
11	4081600598	1	FIX MOTOR FOR COVER D460 3F RAL7016
12	4081600599	1	MOTOR COVER D460 3F M.S2/S3B RAL 7016
13	40000885	1	MOTOR BRUSH KIT V230
13	40000886	1	MOTOR BRUSH KIT V120
1M	40000473	1	KIT FILTER-SHAKER
2M	40000936	1	KIT HEADER ASSEMBLING
3M	40000937	1	MOTOR KIT V230
3M	40000938	1	MOTOR KIT V110 UK
4M	40000939	1	ELECTRICAL KIT V110 UK 3 MOTORS
4M	40000940	1	ELECTRICAL KIT V110 UK 2 MOTORS
4M	40000941	1	ELECTRICAL KIT V230 3 MOTORS
4M	40000942	1	ELECTRICAL KIT V230 2 MOTORS
5M	40000516	1	KIT SWITCH
6M	40000901	1	S2 MOTOR CLOSING KIT
7M	40000909	1	CABLE KIT V230 EU
7M	40000910	1	S2B CABLE KIT V110 UK
7M	40000923	1	S3B CABLE KIT V110 UK

Recommended Spare Parts

S2B - S3B

16-09-2012

Part List ID

15

16

Pos	Part no.	Qty	Description
	40000338	1	KIT STAR FILTER D460 L CLASS
	40000345	1	KIT PUSHBUTTON FOR INLET D70
	40000395	1	KIT DEFLECTOR D70
	40000419	1	KIT CASTORS FOR CONTAINER
	40000864	1	UPRIGHT PROTECTION KIT
	40000866	1	HANDLE KIT L50
	40000867	1	D70 INLET KIT
	40000868	1	D70 INLET FULL KIT
	40000869	1	FILTER CHAMBER KIT
	40000870	1	PROTECTION KIT
	40000871	1	UPRIGHT KIT
	40000872	1	BIN RELEASE KIT
	40000873	1	WHEEL D200 KIT
	40000874	1	KIT REVOLV. CASTOR D150
	40000879	1	HANDLE KIT L100
	40000885	1	MOTOR BRUSH KIT V230
	40000886	1	MOTOR BRUSH KIT V120
	40000909	1	CABLE KIT V230 EU
	40000910	1	S2B CABLE KIT V110 UK
	40000923	1	S3B CABLE KIT V110 UK
	40000937	1	MOTOR KIT V230
	40000938	1	MOTOR KIT V110 UK
	4083000496	1	COMP.BIN D460 L50 M.S2-S3
	4083000497	1	COMP.BIN D460 L100 M.S3
	Z8 33093	1	STAR CAGE D460 MOD.317